

FLUKE®

1587/1577

Insulation Multimeters

Users Manual

PN 2401027
April 2005 Rev.1, 1/06
© 2005-2006 Fluke Corporation. All rights reserved. Printed in USA
All product names are trademarks of their respective companies.

LIMITED WARRANTY AND LIMITATION OF LIABILITY

Each Fluke product is warranted to be free from defects in material and workmanship under normal use and service. The warranty period is three years and begins on the date of shipment. Parts, product repairs, and services are warranted for 90 days. This warranty extends only to the original buyer or end-user customer of a Fluke authorized reseller, and does not apply to fuses, disposable batteries, or to any product which, in Fluke's opinion, has been misused, altered, neglected, contaminated, or damaged by accident or abnormal conditions of operation or handling. Fluke warrants that software will operate substantially in accordance with its functional specifications for 90 days and that it has been properly recorded on non-defective media. Fluke does not warrant that software will be error free or operate without interruption.

Fluke authorized resellers shall extend this warranty on new and unused products to end-user customers only but have no authority to extend a greater or different warranty on behalf of Fluke. Warranty support is available only if product is purchased through a Fluke authorized sales outlet or Buyer has paid the applicable international price. Fluke reserves the right to invoice Buyer for importation costs of repair/replacement parts when product purchased in one country is submitted for repair in another country.

Fluke's warranty obligation is limited, at Fluke's option, to refund of the purchase price, free of charge repair, or replacement of a defective product which is returned to a Fluke authorized service center within the warranty period.

To obtain warranty service, contact your nearest Fluke authorized service center to obtain return authorization information, then send the product to that service center, with a description of the difficulty, postage and insurance prepaid (FOB Destination). Fluke assumes no risk for damage in transit. Following warranty repair, the product will be returned to Buyer, transportation prepaid (FOB Destination). If Fluke determines that failure was caused by neglect, misuse, contamination, alteration, accident, or abnormal condition of operation or handling, including overvoltage failures caused by use outside the product's specified rating, or normal wear and tear of mechanical components, Fluke will provide an estimate of repair costs and obtain authorization before commencing the work. Following repair, the product will be returned to the Buyer transportation prepaid and the Buyer will be billed for the repair and return transportation charges (FOB Shipping Point).

THIS WARRANTY IS BUYER'S SOLE AND EXCLUSIVE REMEDY AND IS IN LIEU OF ALL OTHER WARRANTIES, EXPRESS OR IMPLIED, INCLUDING BUT NOT LIMITED TO ANY IMPLIED WARRANTY OF MERCHANTABILITY OR FITNESS FOR A PARTICULAR PURPOSE. FLUKE SHALL NOT BE LIABLE FOR ANY SPECIAL, INDIRECT, INCIDENTAL OR CONSEQUENTIAL DAMAGES OR LOSSES, INCLUDING LOSS OF DATA, ARISING FROM ANY CAUSE OR THEORY.

Since some countries or states do not allow limitation of the term of an implied warranty, or exclusion or limitation of incidental or consequential damages, the limitations and exclusions of this warranty may not apply to every buyer. If any provision of this Warranty is held invalid or unenforceable by a court or other decision-maker of competent jurisdiction, such holding will not affect the validity or enforceability of any other provision.

Fluke Corporation
P.O. Box 9090
Everett, WA 98206-9090
U.S.A.

Fluke Europe B.V.
P.O. Box 1186
5602 BD Eindhoven
The Netherlands

Table of Contents

Title	Page
Introduction	1
Contacting Fluke	1
Safety Information	2
Accessories	4
Unsafe Voltage.....	4
Test Lead Alert.....	4
Battery Saver (Sleep Mode)	4
Rotary Switch Positions.....	5
Buttons	6
Understanding the Display	8
Input Terminals.....	11
Power-Up Options	12
AutoHold Mode.....	13
MIN MAX AVG Recording Mode	13
Manual Ranging and Autoranging.....	14
Understanding AC Zero Input Behavior of True RMS Meters	15
Low-Pass Filter (Model 1587 and 1587T)	15

Making Basic Measurements	16
Measuring AC and DC Voltage	17
Measuring Temperature (Model 1587 and 1587T).....	18
Measuring Resistance.....	19
Measuring Capacitance (Model 1587 and 1587T)	19
Testing for Continuity	20
Testing Diodes (Model 1587 and 1587T).....	21
Measuring AC or DC Current	22
Testing Insulation	24
Measuring Frequency (Model 1587 and 1587T)	25
Cleaning.....	27
Testing the Batteries	27
Testing the Fuse	27
Replacing the Batteries and Fuse.....	28
Specifications.....	29
General Specifications	29
Electrical Specifications	30
AC Voltage Measurement	30
1587 and 1587T Accuracy	30
1587 and 1587T Low-Pass Filter Voltage	31
1577 Accuracy.....	31
DC Voltage Measurement	32
DC Millivolts Measurement	32
DC and AC Current Measurement	33
Ohms Measurement.....	34
Diode Test (1587 and 1587T Only).....	34
Continuity Test.....	34
Frequency Measurement (1587 and 1587T Only)	35

Frequency Counter Sensitivity.....	35
Capacitance (1587 and 1587T Only).....	35
Temperature Measurement (1587 and 1587T Only)	36
Insulation Specifications	36
Model 1587	37
Model 1577	37
Model 1587T.....	38

List of Tables

Table	Title	Page
1.	Symbols.....	3
2.	Rotary Switch Selections.....	5
3.	Buttons.....	7
4.	Display Indicators.....	8
5.	Error Messages.....	10
6.	Input Terminal Descriptions.....	12
7.	Power-Up Options.....	12

List of Figures

Figure	Title	Page
1.	Rotary Switch	5
2.	Buttons	6
3.	Display Indicators	8
4.	Input Terminals.....	11
5.	Low Pass Filter.....	15
6.	Measuring AC and DC Voltage	17
7.	Measuring Temperature	18
8.	Measuring Resistance	19
9.	Measuring Capacitance.....	19
10.	Testing for Continuity.....	20
11.	Testing Diodes	21
12.	Measuring AC or DC Current	23
13.	Testing Insulation	25
14.	Measuring Frequency.....	26
15.	Testing the Fuse.....	27
16.	Replacing the Fuse and Battery	28

1587/1577 Insulation Multimeters

Introduction

The Fluke Models 1587, 1587T, and 1577 are battery-powered, true-RMS insulation multimeters (hereafter "the Meter") with a 6000-count and a 3 ¾ digit display. Although this manual describes the operation of all models, all illustrations and examples assume use of Model 1587.

These meters meet CAT III and CAT IV IEC 61010 standards. The IEC 61010 standard defines four measurement categories (CAT I to IV) based on the magnitude of danger from transient impulses. CAT III meters are designed to protect against transients in Fixed equipment installations at the distribution level; CAT IV meters are designed to protect against transients from the primary supply level (overhead or underground utility service).

The Meter measures or tests the following:

- AC / DC voltage and current
- Resistance
- Voltage and current frequency
- Temperature (Model 1587)
- Diodes (Model 1587)
- Continuity
- Capacitance (Model 1587)
- Insulation testing

Contacting Fluke

To contact Fluke, call:

1-888-993-5853 in USA
1-800-363-5853 in Canada
+31-402-675-200 in Europe
+81-3-3434-0181 in Japan
+65-738-5655 in Singapore
+1-425-446-5500 from anywhere in the world

Visit Fluke's web site at: www.fluke.com

Register your Meter at: register.fluke.com

Safety Information

Use the Meter only as specified in this manual. Otherwise, the protection provided by the Meter may be impaired. See Table 1 for a list of symbols used on the Meter and in this manual.

A **⚠⚠ Warning** identifies hazardous conditions and actions that could cause bodily harm or death.

A **⚠⚠ Caution** identifies conditions and actions that could damage the Meter, the equipment under test, or cause permanent loss of data.









⚠⚠ Warning

To avoid possible electric shock or personal injury, follow these guidelines:

- **Use the Meter only as specified in this manual or the protection provided by the Meter might be impaired.**
- **Do not use the Meter or test leads if they appear damaged, or if the Meter is not operating properly. If in doubt, have the Meter serviced.**
- **Always use the proper terminal, switch position, and range for measurements before connecting Meter to circuit under test.**
- **Verify the Meter's operation by measuring a known voltage.**
- **Do not apply more than the rated voltage as marked on the Meter, between the terminals or between any terminal and earth ground.**
- **Use caution with voltages above 30 V ac rms, 42 V ac peak, or 60 V dc. These voltages pose a shock hazard.**
- **Replace the battery as soon as the low battery indicator () appears.**
- **Disconnect circuit power and discharge all high-voltage capacitors before testing resistance, continuity, diodes, or capacitance.**
- **Do not use the Meter around explosive gas or vapor.**
- **When using the test leads, keep your fingers behind the finger guards.**

- **Remove test leads from the Meter before opening the Meter case or battery door. Never operate the Meter with the cover removed or the battery door open.**
- **Comply with local and national safety requirements when working in hazardous locations.**
- **Use proper protective equipment, as required by local or national authorities when working in hazardous areas.**
- **Avoid working alone.**
- **Use only the replacement fuse specified or the protection may be impaired.**
- **Check the test leads for continuity before use. Do not use if the readings are high or noisy.**

Table 1. Symbols

	AC (Alternating Current)		Earth Ground
	DC (Direct Current)		Fuse
	WARNING: risk of electric shock.		Double Insulated
	Battery (Low battery when shown on display.)		Important information; see manual

Accessories

Model	Leads	Probes	Clips	Holster	Hard Case	K Type Thermocouple	Remote Probe
1587 and 1587T	TL224	TP74	AC285	Yes	Yes	Yes	Yes
1577	TL224	TL74	AC285	Yes	Yes	No	Yes

Unsafe Voltage

To alert you to the presence of a potentially hazardous voltage, when the Meter detects a voltage ≥ 30 V or a voltage overload (OL), the ⚡ symbol is displayed.

Test Lead Alert

To remind you to check that the test leads are in the correct terminals, LEAD is momentarily displayed when you move the rotary switch to or from the mA position.

Warning

To avoid a blown fuse, damage to the Meter, or serious personal injury, never attempt to make a measurement with a test lead in an incorrect terminal.

Battery Saver (Sleep Mode)

The Meter enters the “Sleep mode” and blanks the display if there is no function change or button press for 20 minutes. This done to conserve battery power. The Meter comes out of Sleep mode when a key is pressed or when the rotary switched is turned.

To disable the Sleep mode, hold down the blue button while turning the Meter on. Sleep mode is always disabled in the MIN MAX AVG recording mode, AutoHold mode, insulation test active, or if the auto power off feature has been disabled by pressing the blue button when the Meter is turned on.

Rotary Switch Positions

Turn the Meter on by selecting any measurement function. The Meter presents a standard display for that function (range, measurement units, modifiers, etc.). Use the blue button to select any rotary switch alternate functions (labelled with blue letters). Rotary switch selections are shown in Figure 1 and described in Table 2.

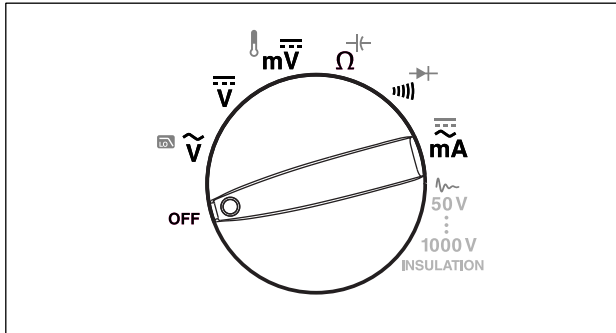





bav02f.eps

Figure 1. Rotary Switch

Table 2. Rotary Switch Selections

Switch Position	Measurement Function
\tilde{V}	AC voltage from 30.0 mV to 1000 V.
\tilde{V} (1587 and 1587T only)	AC voltage with 800 Hz “low-pass” filter.
\bar{V}	DC voltage 1 mV to 1000 V.
$m\bar{V}$	DC mV 0.1 mV to 600 mV.
$\text{m}\bar{A}$ (1587 and 1587T only)	Temperature from - 40 °C to + 537 °C (- 40 °F to + 998 °F). Celsius is the default temperature measurement unit. The temperature measurement you select is retained in memory when the Meter is turned off.
Ω	Ohms from 0.1 Ω to 50 M Ω .
$\text{m}\bar{A}$ (1587 and 1587T only)	Capacitance from 1 nF to 9999 μF .

Table 2. Rotary Switch Selections (cont.)

Switch Position	Measurement Function
)	Continuity test. Beeper turns on at <25 Ω and turns off at >100 Ω .
 (1587 and 1587T only)	Diode test. There is no ranging in this function. Displays  above 6.600 V.
 mA	AC mA from 3.00 mA to 400 mA (600 mA overload for 2 minutes maximum). DC mA from 0.01 mA to 400 mA (600 mA overload for 2 minutes maximum).
 INSULATION	Ohms from 0.01 M Ω to 2 G Ω . Performs insulation test with 50, 100, 250, 500 (default), and 1000 V source on the 1587 or 500 (default) and 1000 V source on the 1577 or 50 V (default) and 100 V on the 1587T. The last selected high voltage setting is retained in memory when the Meter is turned off. Press the blue button to activate smoothing during insulation testing (1587 only).

Buttons



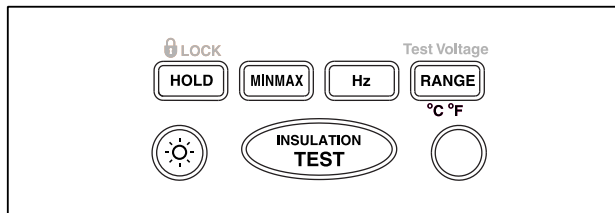

Use the buttons to activate features that augment the function selected with the rotary switch. The buttons are shown in Figure 2 and described in Table 3.







bav03f.eps

Figure 2. Buttons

Table 3. Buttons

Button	Description
	<p>Press to freeze the displayed value. Press again to release the display.</p> <p>When a reading changes, the display updates and the Meter beeps.</p> <p>In MIN MAX AVG or Hz mode, this button operates a display hold.</p> <p>In Insulation Test mode, this schedules a test lock the next time you press  on the Meter or on the remote probe. The test lock acts to hold down the button until your press  or  again to release the lock.</p>
 (1587 and 1587T only)	<p>Press to start retaining maximum, minimum, and average values. Press successively to display maximum, minimum, and average values. Press and hold to cancel MIN MAX AVG.</p>

Button	Description
 (1587 and 1587T only)	<p>Activate frequency measurement.</p>
	<p>Changes Ranging mode from Auto (default) to Manual Ranging mode. Press and hold to return to Auto Ranging mode.</p>
	<p>Turns the backlight on and off. The backlight goes off after 10 minutes.</p>
	<p>Initiates an insulation test when the rotary switch is on the INSULATION position. Causes the Meter to source (output) a high voltage and measure insulation resistance.</p>
	<p>The blue button. Functions as a shift key. Press to access blue functions on the rotary switch.</p>

Understanding the Display

Display indicators are shown in Figure 3 and described in Table 4. Error messages that may appear on the display are described in Table 5.





Figure 3. Display Indicators

bav01f.eps

Table 4. Display Indicators

Indicator	Description
	<p>Low battery. Indicates when it is time to replace the battery. When is on, the backlight button is disabled to conserve battery life.</p> <p>Warning</p> <p>To avoid false readings, which could lead to possible electric shock or personal injury, replace the battery as soon as the low battery indicator appears.</p>
 LOCK	<p>Indicates a test lock will be applied the next time you press on the Meter or on the remote probe. The test lock acts to hold down the button until you press or again.</p>
- >	Minus, or greater than symbols

Table 4. Display Indicators (cont.)

Indicator	Description
	Unsafe voltage warning. Indicates 30 V or greater (ac or dc depending on the rotary switch position) is detected on the input. Also appears when the display shows Ω in the \tilde{V} , \bar{V} , or $m\bar{V}$ switch positions, and when batt appears on the display. The f also appears when insulation test is active, or in Hz.
	“Smoothing” enabled. Smoothing dampens display fluctuations of rapidly changing inputs by digital filtering. Smoothing is available for insulation testing on Model 1587 only. For more on smoothing, see Power-Up options.
 (1587 and 1587T only)	Indicates the low-pass filter function for ac volts is selected.









Indicator	Description
 	Indicates AutoHold is active. Indicates display hold is active.
 MAX MIN AVG (1587 and 1587T only)	Indicates minimum, maximum, or average reading has been selected using the  button.
	Continuity test function is selected
 (1587 and 1587T only)	Diode test function is selected
nF, μF, °C, °F, AC, DC, Hz, kHz, Ω, kΩ, MΩ, GΩ	Measurement units
	Primary display
V_{DC}	Volts
	Secondary display

Table 4. Display Indicators (cont.)

Feature	Description
Auto Range ManualRange 61000mV	Display range in use
2500V 1000V	Source voltage rating for insulation test: 50, 100, 250, 500 (default) or 1000 V on the 1587. 500 (default) and 1000 V ranges available on the 1577. 50 (default) and 100 V on the 1587T.
	Insulation test indicator. Appears when insulation test voltage is present.

Table 5. Error Messages



Message	Description
batt	Appears on the primary display and indicates that the battery is too low for reliable operation. The Meter will not operate at all until the battery is replaced. The  also appears when batt is on the primary display.
bdt	Appears on the secondary display and indicates that the battery is too low to perform an insulation test. The  button is disabled until the battery is replaced. This message disappears when the rotary switch is turned to any other function.
OPEn	Appears when an open thermocouple is detected.
LEAd	Test lead alert. The message appears briefly and a single beep will sound when you move the switch in or out of the  position.
IS--Err	Model detect error. Service Meter if this is displayed.

Table 5. Error Messages (cont.)

Message	Description
d 5c	Meter cannot discharge a capacitor.
EPPr Err	Invalid EEPROM data. Have the Meter serviced.
CAL Err	Invalid calibration data. Calibrate the Meter.

Input Terminals

Input terminals are shown in Figure 4 and described in Table 6.

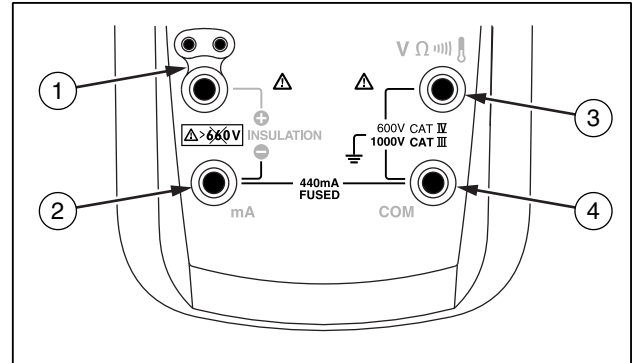

bav04f.eps

Figure 4. Input Terminals

Table 6. Input Terminal Descriptions

Item	Description
①	\oplus input terminal for insulation test.
②	\ominus input terminal for insulation test. Use for ac and dc milliamp measurements to 400 mA and current frequency measurements.
③	Input terminal for voltage, continuity, resistance, diode, capacitance, voltage frequency, and temperature (Model 1587 and 1587T only) measurements.
④	Common (return) terminal for all measurements except insulation test.

Power-Up Options

Holding a button down while turning the Meter on activates a power-up option. Power-up options allow you to use additional features and functions of the Meter. To select a power-up option, hold down the appropriate button indicated while turning the Meter from **OFF** to any switch position. Power-up options are cancelled when the Meter is turned **OFF**. Power-up options are described in Table 7.



Table 7. Power-Up Options

Button	Description
	\tilde{V} switch position turns on all LCD segments. \bar{V} switch position displays the software version number. $m\bar{V}$ switch position displays the model number.
HOLD	INSULATION switch position initiates a fully loaded battery test and displays the charge level of the battery until the button is released. The remaining positions show all LCD segments.
RANGE	Enables "Smoothing" mode for all of the functions except insulation. The display shows 5 - - - until the button is released. Smoothing dampens display fluctuations of rapidly changing inputs by digital filtering.

Note

Power Up options are active when the button is pressed.

Table 7. Power-Up Options (cont.)



Button	Description
 (Blue)	<p>Disables automatic power-off ("Sleep mode"). Display shows PaFF until the button is released.</p> <p>Sleep mode is also disabled while the Meter is in a MIN MAX AVG Recording mode, AutoHold mode, and when performing an insulation test.</p>
	<p>Starts the Calibration mode. The Meter displays [0] and enters Calibration mode when the button is released.</p>
	<p>Disables the beeper. The display shows bEEP until the button is released.</p>

AutoHold Mode

⚠ ⚠ Warning

To avoid electric shock, do not use the Display AutoHold mode to determine if a circuit is live. Unstable or noisy readings will not be captured.

In the AutoHold mode, the Meter holds the reading on the display until it detects a new stable reading. Then the Meter beeps and displays the new reading.

- Press  to activate AutoHold.  appears.
- Press  again or turn the rotary switch to resume normal operation.

MIN MAX AVG Recording Mode

The MIN MAX AVG mode records minimum and maximum input values. When the inputs go below the recorded minimum value or above the recorded maximum value, the Meter beeps and records the new value. This mode can be used to capture intermittent readings, record maximum readings while you are away or record readings while you are operating the equipment under test and cannot watch the Meter. MIN MAX AVG mode can also calculate an average of all readings taken since the MIN MAX AVG mode was activated.

The Meter tracks the minimum, maximum, and average values for each display which are updated 4 times per second.

To use MIN MAX AVG recording:

- Make sure the Meter is in the desired measurement function and range. (Autoranging is disabled in the MIN MAX AVG mode).
- Press **MINMAX** to activate MIN MAX AVG mode. **MIN MAX** appears on the display.
- Press **MINMAX** to step through the high (MAX), low (MIN), average (AVG), and present readings.
- To pause MIN MAX AVG recording without erasing stored values, press **HOLD**. **HOLD** is displayed.
- To resume MIN MAX AVG recording, press **HOLD** again. **HOLD** turns off.
- To exit and erase stored readings, press **MINMAX** for one second or turn the rotary switch.

Manual Ranging and Autoranging

The Meter has both Manual Range and Autorange modes.

- In the Autorange mode, the Meter selects the range with the best resolution.
- In the Manual Range mode, you override Autorange and select the range yourself.

When you turn the Meter on, it defaults to Autorange and **Auto Range** is displayed.

1. To enter the Manual Range mode, press **RANGE**. **Manual Range** is displayed.
2. In the Manual Range mode, press **RANGE** to increment the range. After the highest range, the Meter wraps to the lowest range.

Note

You cannot manually change the range in the MIN MAX AVG, or Display HOLD modes.

*If you press **RANGE** while in MIN MAX AVG, or Display HOLD the Meter beeps twice, indicating an invalid operation, and the range does not change.*

3. To exit Manual Range, press **RANGE** for one second or turn the rotary switch. The Meter returns to Autorange and **Auto Range** is displayed.

Understanding AC Zero Input Behavior of True RMS Meters

True RMS Meters accurately measure distorted waveforms, but when the input leads are shorted together in the AC functions, the Meter displays a residual reading between 1 and 30 counts. When the test leads are open, the display readings may fluctuate due to interference. These offset readings are normal. They do not affect the Meter's ac measurement accuracy over the specified measurement ranges.

Unspecified input levels are:

- AC voltage: below 5% of 600 mV ac, or 30 mV ac.
- AC current: below 5% of 60 mA ac, or 3 mA ac.

Low-Pass Filter (Model 1587 and 1587T)

The 1587 is equipped with an ac low-pass filter. When measuring ac voltage or ac frequency (\tilde{V}), press the blue button to activate the Low-Pass Filter function (LO). The Meter continues measuring in the selected ac mode, but now the signal diverts through a filter that blocks unwanted frequencies above 800 Hz. Refer to Figure 5. The low pass filter can improve measurement performance on

composite sine waves that are typically generated by inverters and variable frequency motor drives.

⚠ ⚠ Warning

To avoid possible electric shock or personal injury, do not use the Low-Pass Filter function to verify the presence of hazardous voltages. Voltages greater than what is indicated may be present. First, make a voltage measurement without the filter to detect the possible presence of hazardous voltage. Then, select the filter function.

Note

*When using the Low-Pass filter function, the Meter goes to Manual mode. Select ranges by pressing the **RANGE** button. Autoranging is not available with the Low-Pass filter function.*

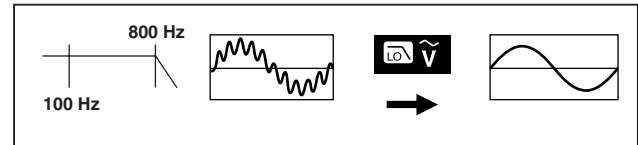

bav16f.eps

Figure 5. Low Pass Filter

Making Basic Measurements

The figures on the following pages show how to make basic measurements.

When connecting the test leads to the circuit or device, connect the common (**COM**) test lead before connecting the live lead; when removing the test leads, remove the live lead before removing the common test lead.

Warning

To avoid electric shock, injury, or damage to the Meter, disconnect circuit power and discharge all high-voltage capacitors before testing resistance, continuity, diodes, or capacitance.

For better accuracy when measuring the dc offset of an ac voltage, measure the ac voltage first. Note the ac voltage range, then manually select a dc voltage range equal to or higher than the ac range. This procedure improves the accuracy of the dc measurement by ensuring that the input protection circuits are not activated.

Measuring AC and DC Voltage

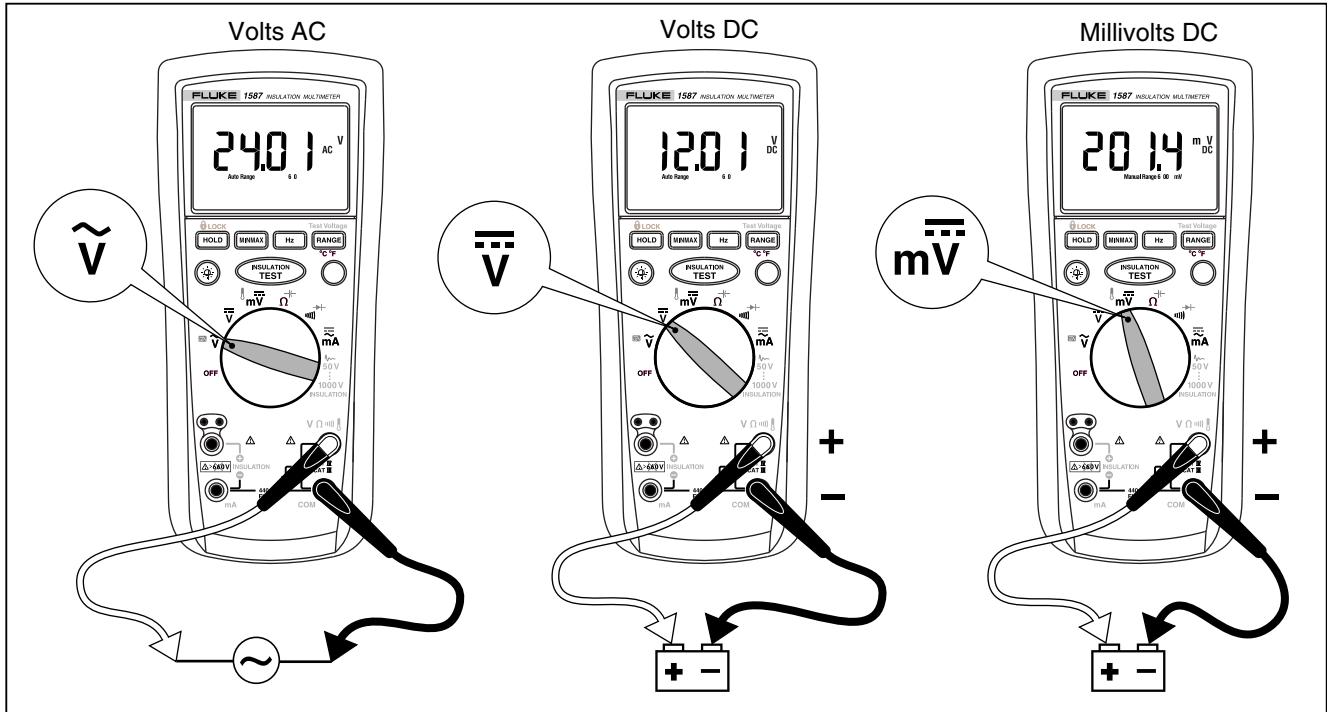

Figure 6. Measuring AC and DC Voltage

bav05f.eps

Measuring Temperature (Model 1587 and 1587T)

The Meter measures the temperature of a type-K thermocouple (included). Choose between degrees Celsius (°C) or degrees Fahrenheit (°F) by pressing **[RANGE]**.

⚠⚠ Caution

To avoid possible damage to the Meter or other equipment, remember that while the Meter is rated for -40 °C to 537 °C (-40 °F to 998.0 °F), the included K-type thermocouple is rated for 260 °C (500 °F). For temperatures out of that range, use a higher rated thermocouple.

⚠⚠ Warning

To avoid risk of shock do not connect thermocouple to electrically live circuits.

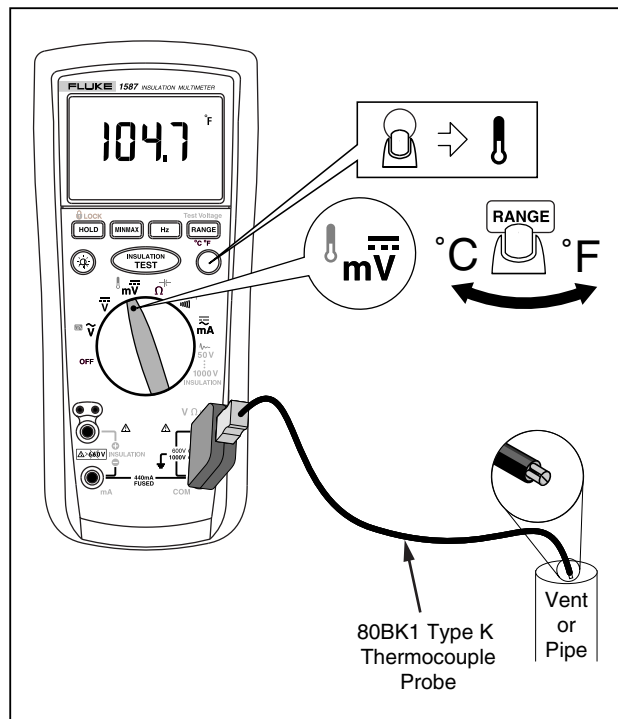

Figure 7. Measuring Temperature

bav09f.eps

Measuring Resistance

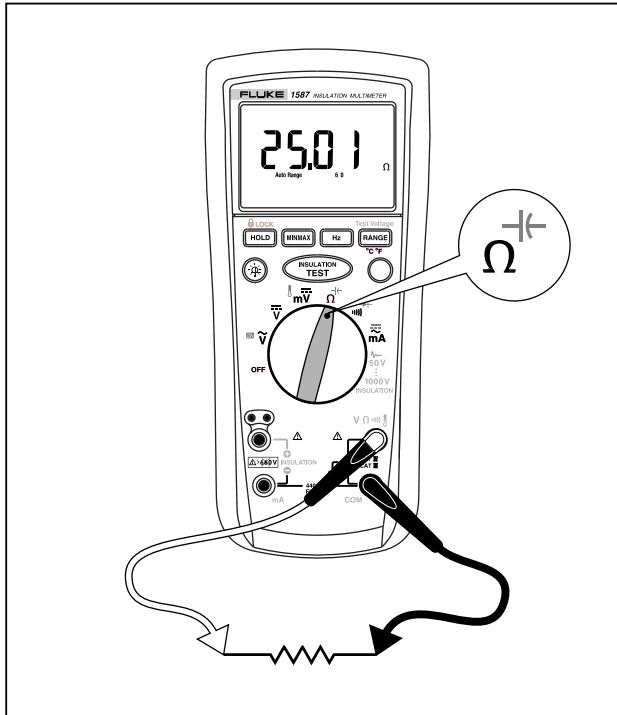

Figure 8. Measuring Resistance

bav06f.eps

Measuring Capacitance (Model 1587 and 1587T)

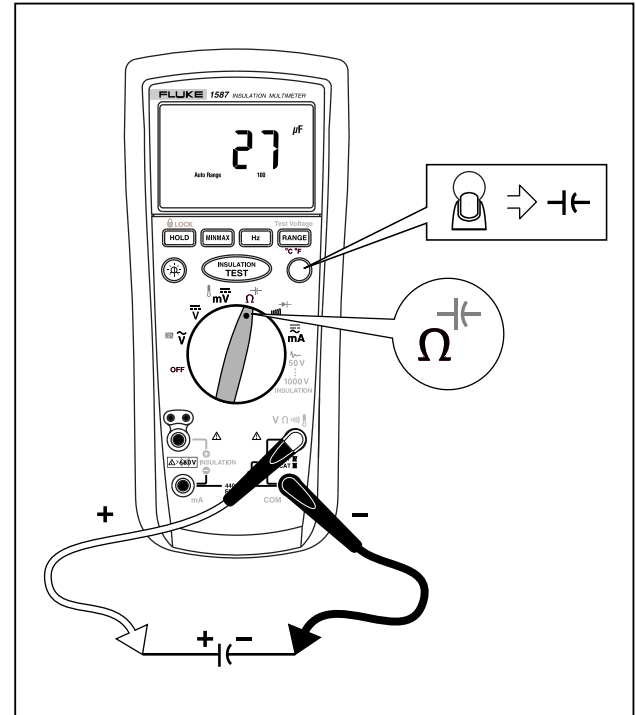

Figure 9. Measuring Capacitance

bav07f.eps

Testing for Continuity

The continuity test features a beeper that sounds as long as a circuit is complete. The beeper allows you to perform quick continuity tests without having to watch the display. To test for continuity, set up the Meter as shown in Figure 10. The beeper sounds when a short ($<25 \Omega$) is detected.

⚠⚠ Caution

To avoid possible damage to the Meter or to the equipment under test, disconnect circuit power and discharge all high voltage capacitors before testing for continuity.

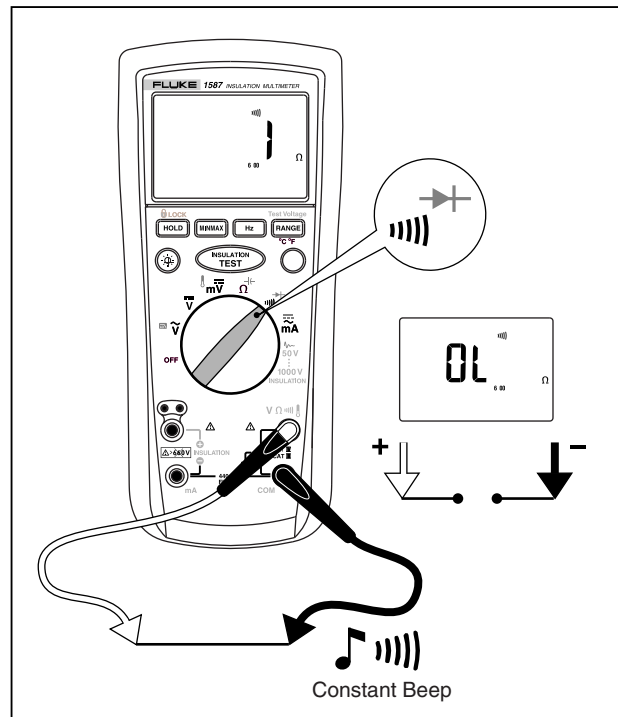

bav08f.eps

Figure 10. Testing for Continuity

Testing Diodes (Model 1587 and 1587T)

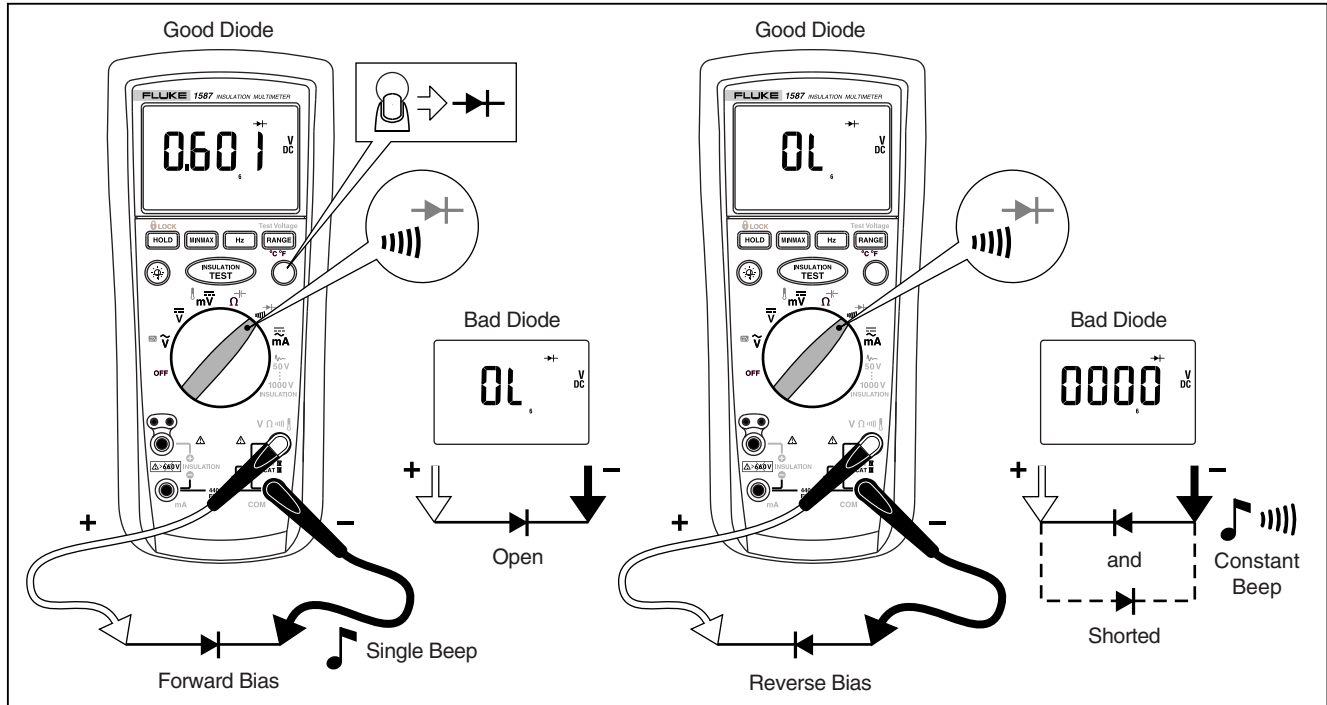

Figure 11. Testing Diodes

Measuring AC or DC Current

Warning

To avoid personal injury or damage to the Meter:

- Never attempt to make an in-circuit current measurement when the open-circuit potential to earth is > 1000 V.
- Check the Meter's fuses before testing. See Testing the Fuses later in this manual.
- Use the proper terminals, switch position, and range for your measurement.
- Never place the probes in parallel with a circuit or component when the leads are plugged into the current terminals.

Turn power **OFF** to the circuit under test, break circuit, insert Meter in series, turn power **ON**. To measure ac or dc current, set up the Meter as shown in Figure 12.

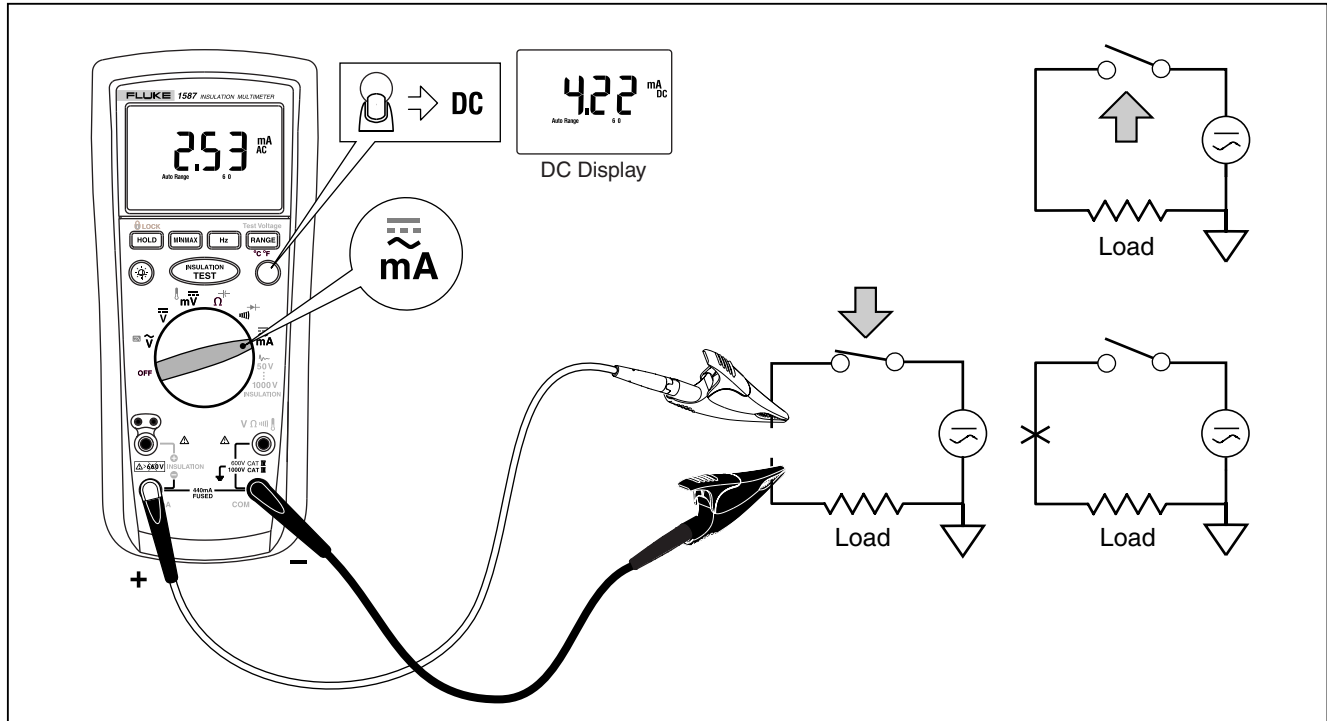









Figure 12. Measuring AC or DC Current





bav11f.eps

Testing Insulation

Insulation tests should only be performed on dead circuits. Check the fuse before testing. See Testing the Fuse later in this manual. To measure insulation resistance set up the Meter as shown in Figure 13 and follow the steps below:

1. Insert test probes in the  and  input terminals.
2. Turn the knob to **INSULATION** position. A battery load check is initiated when the switch is moved to this position. If the battery fails the test  and  appear in the lower display. Insulation tests cannot be performed until the batteries are replaced.
3. Press  to select the voltage.
4. Connect the probes to the circuit to be measured. The Meter automatically detects if the circuit is energized.
 - The primary display shows - - - - until you press  and a valid insulation resistance reading is obtained.

- The high voltage symbol () along with a primary display of >30 V warns if voltage more than 30 V ac or dc is present. In this condition, the test is inhibited. Disconnect the Meter and remove power before proceeding.

5. Push and hold  to start the test. The secondary display shows the test voltage applied to the circuit under test. The high voltage symbol () along with a primary display showing the resistance in MΩ or GΩ appears. The  icon appears on the lower portion of the display until  is released.

When resistance is higher than the maximum display range, the Meter displays the  symbol and the maximum resistance for the range.

6. Keep the probes on the test points and release the  button. The circuit under test then discharges through the Meter. The resistance reading appears on the primary display until a new test is started or a different function or range is selected or > 30 V is detected.

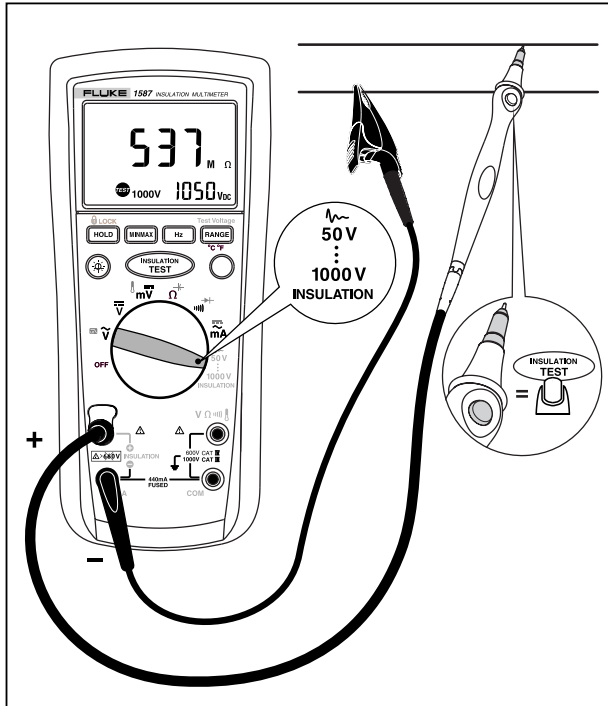

Figure 13. Testing Insulation

bav13f.eps

Measuring Frequency (Model 1587 and 1587T)

The Meter measures the frequency of a voltage or current signal by counting the number of times the signal crosses a threshold level each second. To measure frequency, set up the Meter as shown in Figure 14 and follow the steps below.

1. Connect the Meter to the signal source.
2. Turn the rotary switch to the \tilde{V} , \overline{V} , or \overline{mA} position.
3. In the \overline{mA} position press the blue button to select dc if needed.
4. Press the **Hz** button.
5. Press the blue button, the **Hz** button, or change the rotary switch position to end this function

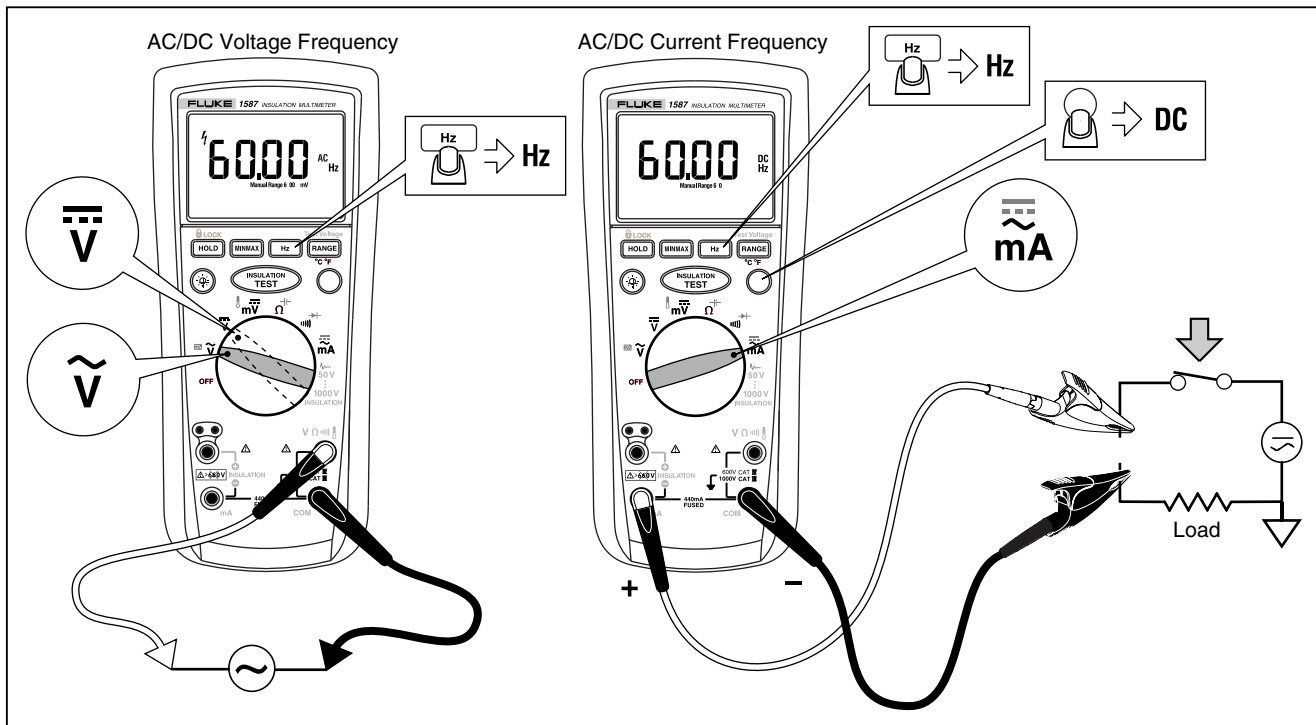

Figure 14. Measuring Frequency

bav12f.eps

Cleaning

Periodically wipe the case with a damp cloth and mild detergent. Do not use abrasives or solvents. Dirt or moisture in the terminals can affect readings.

Testing the Batteries

To test the batteries, press **HOLD** and turn to the rotary switch to the **INSULATION** position. This initiates a battery test and displays the charge level of the battery.

Testing the Fuse

⚠⚠ Warning

To avoid electrical shock or injury, remove the test leads and any input signals before replacing the fuse.

Test the fuse as described below and shown in Figure 15. Replace the fuse as shown in Figure 16.

1. Insert a test probe in the **V Ω** input terminal.
2. Turn the rotary switch to the Ω^{tr} position and verify the Meter is in Auto Range.
3. Insert the probe in the **mA** input terminal. If the display reading is **OL**, the fuse is bad and should be replaced.

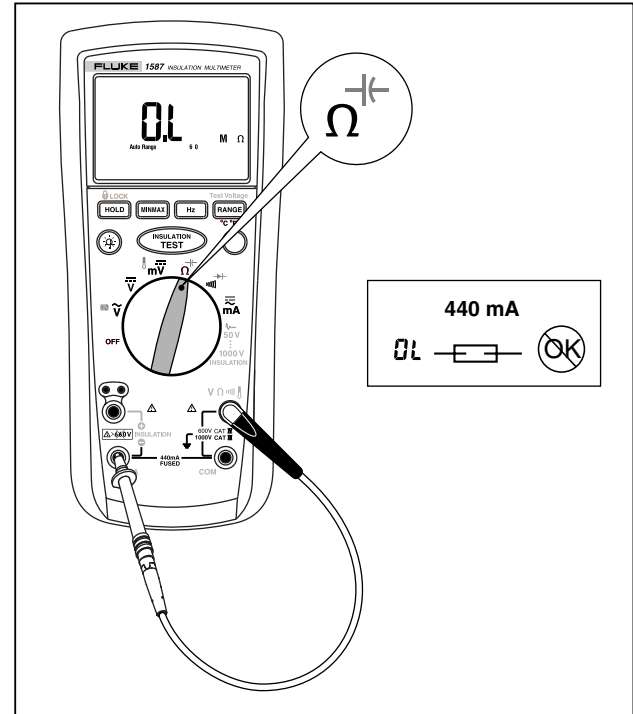

Figure 15. Testing the Fuse

bav14f.eps

Replacing the Batteries and Fuse

Replace the fuse and batteries as shown in Figure 16. Follow the steps below to replace the batteries.

⚠ ⚠ Warning

To avoid shock, injury, or damage to the Meter:

- **To avoid false readings, which could lead to possible electric shock or personal injury, replace the batteries as soon as the battery indicator (🔋) appears.**
- **Use ONLY fuses with the amperage, interrupt, voltage, and speed ratings specified.**
- **Turn the rotary switch to OFF and remove the test leads from the terminals.**

1. Remove the battery door by using a standard screwdriver to turn the battery door lock until the unlock symbol aligns with the arrow.
2. Remove and replace the batteries.
3. Replace the battery door and secure by turning the battery door lock until the lock symbol aligns with the arrow.

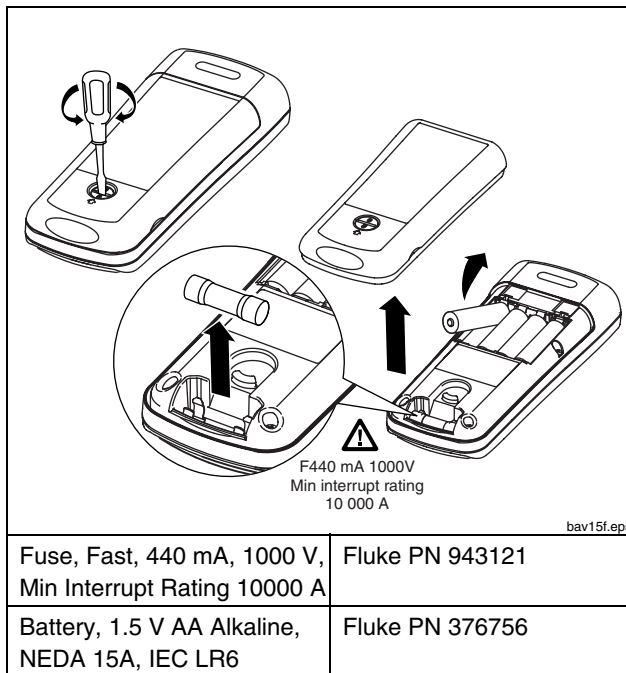

Figure 16. Replacing the Fuse and Battery

Specifications

General Specifications

Maximum Voltage Applied to any Terminal.....	1000 V ac rms or dc
Storage Temperature	-40 °C to 60 °C (-40 °F to 140 °F)
Operating Temperature	-20 °C to 55 °C (-4 °F to 131 °F)
Temperature Coefficient.....	0.05 x (specified accuracy) per °C for temperatures < 18 °C or > 28 °C (< 64 °F or > 82 °F)
Relative Humidity	Noncondensing 0 % to 95 % @ 10 °C to 30 °C (50 °F to 86 °F) 0 % to 75 % @ 30 °C to 40 °C (86 °F to 104 °F) 0 % to 40 % @ 40 °C to 55 °C (104 °F to 131 °F)
Vibration	Random, 2 g, 5-500 Hz per MIL-PRF-28800F, Class 2 instrument
Shock	1 meter drop per IEC 61010-1 2 nd Edition (1 meter drop test, six sides, oak floor)
Electromagnetic Compatibility	In an RF field of 3 V/M, accuracy = specified accuracy except in temperature: accuracy = specified accuracy ± 5 °C (9 °F). (EN 61326-1:1997).
Safety	Complies with ANSI/ISA 82.02.01 (61010-1) 2004, CAN/CSA-C22.2 NO. 61010-1-04, and IEC/EN 61010-1 2 nd Edition for measurement category III 1000 V (CAT III) and CAT IV 600 V.
Certifications.....	CSA per standard CSA/CAN C22.2 No. 61010.1-04; TUV per standard EN 61010 Part 1-1002
Batteries	Four AA batteries (NEDA 15A or IEC LR6)
Battery Life	Meter use 1000 hours; Insulation test use: Meter can perform at least 1000 insulation tests with fresh alkaline batteries at room temperature. These are standard tests of 1000 V into 1 MΩ with a duty cycle of 5 seconds on and 25 seconds off.
Size	5.0 cm H x 10.0 cm W x 20.3 cm L (1.97 in H x 3.94 in W x 8.00 in L)
Weight	550 g (1.2 lb.)
IP Rating.....	IP40

Altitude

Operating 2000 m CAT III 1000 V, CAT IV 600 V; 3000 m CAT II 1000 V, CAT III 600 V

Storage..... 12,000 m

Over-Range Capability..... 110% of range except for capacitance which is 1 %

Compliance to EN 61557 IEC61557-1, IEC61557-2

Electrical Specifications

AC Voltage Measurement

1587 and 1587T Accuracy

Range	Resolution	50 Hz to 60 Hz ± (% of Rdg + Digits)	60 Hz to 5000 Hz ± (% of Rdg + Digits)
600.0 mV	0.1 mV	$\pm (1 \% + 3)$	$\pm (2 \% + 3)$
6.000 V	0.001 V	$\pm (1 \% + 3)$	$\pm (2 \% + 3)$
60.00 V	0.01 V	$\pm (1 \% + 3)$	$\pm (2 \% + 3)$
600.0 V	0.1 V	$\pm (1 \% + 3)$	$\pm (2 \% + 3)$ ^[1]
1000 V	1 V	$\pm (2 \% + 3)$	$\pm (2 \% + 3)$ ^[1]

[1] 1 kHz bandwidth.

1587 and 1587T Low-Pass Filter Voltage

Range	Resolution	50 Hz to 60 Hz ± (% of Rdg + Digits)	60 Hz to 400 Hz ± (% of Rdg + Digits)
600.0 mV	0.1 mV	± (1 % + 3)	+ (2 % + 3) - (6 % - 3)
6.000 V	0.001 V	± (1 % + 3)	+ (2 % + 3) - (6 % - 3)
60.00 V	0.01 V	± (1 % + 3)	+ (2 % + 3) - (6 % - 3)
600.0 V	0.1 V	± (1 % + 3)	+ (2 % + 3) - (6 % - 3)
1000 V	1 V	± (2 % + 3)	+ (2 % + 3) - (6 % - 3)

1577 Accuracy

Range	Resolution	50 Hz to 60 Hz ± (% of Rdg + Digits)
600.0 mV	0.1 mV	± (2 % + 3)
6.000 V	0.001 V	± (2 % + 3)
60.00 V	0.01 V	± (2 % + 3)
600.0 V	0.1 V	± (2 % + 3)
1000 V	1 V	± (2 % + 3)

AC ConversionInputs are ac-coupled and calibrated to the rms value of sine wave input. Conversions are true-rms responding and specified from 5 % to 100 % of range. Input signal crest factor can be up to 3 up to 500 V, decreasing linearly to crest factor ≤ 1.5 at 1000 V. For non-sinusoidal waveforms add ± (2 % reading + 2 % FS) typical, for a crest factor up to 3.

Input Impedance.....10 MΩ (nominal), <100 pF, ac-coupled

Common Mode Rejection Ratio

(1 kΩ unbalanced).....>60 dB at dc, 50 or 60 Hz

Overload Protection 1000 V rms or dc, 10⁷ V Hz Max

DC Voltage Measurement

Range	Resolution	Accuracy 1587 and 1587T ^[1] ± (% of Rdg + Digits)	Accuracy 1577 ^[1] ± (% of Rdg + Digits)
6.000 V dc	0.001 V	± (0.09 % + 2)	± (0.2 % + 2)
60.00 V dc	0.01 V	± (0.09 % + 2)	± (0.2 % + 2)
600.0 V dc	0.1 V	± (0.09 % + 2)	± (0.2 % + 2)
1000 V dc	1 V	± (0.09 % + 2)	± (0.2 % + 2)

[1] Accuracies apply to ± 100% of range.

Input Impedance 10 MΩ (nominal), < 100 pF

Normal Mode Rejection Ratio > 60 dB @ 50 Hz or 60 Hz

Common Mode Rejection Ratio>120 dB @ dc, 50 Hz or 60 Hz (1 k unbalance)

Overload Protection 1000 V rms or dc

DC Millivolts Measurement

Range	Resolution	Accuracy 1587 and 1587T ± (% of Rdg + Digits)	Accuracy 1577 ± (% of Rdg + Digits)
600.0 mV dc	0.1 mV	± (0.1 % + 1)	± (0.2 % + 1)

DC and AC Current Measurement

Range		Resolution	Accuracy 1587 and 1587T ± (% of Rdg+Digits)	Accuracy 1577 ± (% of Rdg+Digits)	Burden Voltage (Typical)
AC 45 Hz to 1000 Hz	400 mA	0.1 mA	± (1.5 % + 2) ^[1]	± (2 % + 2) ^[1]	2 mV/mA
	60 mA	0.01 mA	± (1.5 % + 2) ^[1]	± (2 % + 2) ^[1]	
DC	400 mA	0.1 mA	± (0.2 % + 2)	± (1.0 % + 2)	2 mV/mA
	60 mA	0.01 mA	± (0.2 % + 2)	± (1.0 % + 2)	

[1] 1 kHz bandwidth.

Overload600 mA for 2 minutes maximum

Overload Protection.....440 mA, 1000 V, FAST fuse

AC ConversionInputs are ac-coupled and calibrated to the rms value of sine wave input. Conversions are true-rms responding and specified from 5 % to 100 % of range. Input signal crest factor can be up to 3 up to 300 mA, decreasing linearly to crest factor <= 1.5 at 600 mA. For non-sinusoidal waveforms add +(2 % reading + 2 % FS) typical, for a crest factor up to 3.

Ohms Measurement

Range	Resolution	Accuracy 1587 and 1587T ^[1] + (% of Rdg+Digits)	Accuracy 1577 ^[1] + (% of Rdg+Digits)
600.0 Ω	0.1 Ω	± (0.9 % + 2)	± (1.2 % + 2)
6.000 kΩ	0.001 kΩ		
60.00 kΩ	0.01 kΩ		
600.0 kΩ	0.1 KΩ		
6.000 MΩ	0.001 MΩ		
50.0 MΩ	0.01 MΩ	± (1.5 % + 3)	± (2.0 % + 3)

[1] Accuracies apply from 0 to 100% of range.

Overload Protection 1000 V rms or dc

Open Circuit Test Voltage < 8.0 V dc

Short Circuit Current < 1.1 mA

Diode Test (1587 and 1587T Only)

Diode Test Indication Display voltage drop: 0.6 V at 1.0 mA nominal test current:

Accuracy +(2 % + 3)

Continuity Test

Continuity Indication Continuous audible tone for test resistance below 25 Ω and off above 100 Ω. Maximum Reading; 1000 Ω

Open Circuit Voltage < 8.0 V

Short Circuit Current 1.0 mA typical

Overload Protection 1000 V rms

Response Time > 1 m sec

Frequency Measurement (1587 and 1587T Only)

Range	Resolution	Accuracy \pm (% of Rdg+Digits)
99.99 Hz	0.01 Hz	\pm (0.1 % + 1)
999.9 Hz	0.1 Hz	\pm (0.1 % + 1)
9.999 kHz	0.001 kHz	\pm (0.1 % + 1)
99.99kHz	0.01 kHz	\pm (0.1 % + 1)

Frequency Counter Sensitivity

Input Range	V ac Sensitivity (RMS Sine Wave) ^[1]		DC Trigger Levels ^[1] to 20 kHz ^[2]
	5 Hz to 20 kHz	20 kHz to 100 kHz	
600.0 mV ac	100.0 mV	150.0 mV	na
6.0 V	1.0 V	1.5 V	-400.0 mV and 2.5 V
60.0 V	10.0 V	36.0 V	1.2 V and 4.0 V
600.0 V	100.0 V	-	12.0 V and 40.0 V
1000.0 V	300.0 V	-	12.0 V and 40.0 V

[1] Maximum input for specified accuracy = 10x range (1000 V max). Noise at low frequencies and amplitudes may affect accuracy.
 [2] Usable to 100 kHz with full scale input.

Capacitance (1587 and 1587T Only)

Range	Resolution	Accuracy \pm (% of Rdg+Digits)
1000 nF	1 nF	\pm (1.2 % + 2)
10.00 μ F	0.01 μ F	
100.0 μ F	0.1 μ F	\pm (1.2 % +/- 90 counts)
9999 μ F	1 μ F	

Temperature Measurement (1587 and 1587T Only)

Range	Resolution	Accuracy ^[1] ± (% of Rdg+Digits)
-40 °C to 537 °C	0.1 °C	± (1 % + 10 counts)
-40 °F to 998 °F	0.1 °F	± (1 % + 18 counts)

[1] Accuracies apply following 90 minutes settling time after a change in the ambient temperature of the instrument.

Insulation Specifications

Measurement Range

- Model 15870.01 MΩ to 2 GΩ
- Model 15770.1 MΩ to 600 MΩ
- Model 1587T0.01 MΩ to 100 MΩ

Test Voltages

- Model 158750, 100, 250, 500, 1000 V
- Model 1577500, 1000 V
- Model 1587T50, 100 V

Test Voltage Accuracy+ 20 %, - 0 %

Short-Circuit Test Current1 mA nominal

Auto Discharge.....Discharge time <0.5 second for C = 1 μF or less

Live Circuit Detection:Inhibit test if terminal voltage > 30 V prior to initialization of test.

Maximum Capacitive Load.....Operable with up to 1 μF load.

Model 1587

Output Voltage	Display Range	Resolution	Test Current	Resistance Accuracy ± (% of Rdg + Digits)
50 V (0 % to + 20 %)	0.01 to 6.00 MΩ	0.01 MΩ	1 mA @ 50 kΩ	± (3 % + 5 counts)
	6.0 to 50.0 MΩ	0.1 MΩ		
100 V (0 % to + 20 %)	0.01 to 6.00 MΩ	0.01 MΩ	1 mA @ 100 kΩ	± (3 % + 5 counts)
	6.0 to 60.0 MΩ	0.1 MΩ		
	60 to 100 MΩ	1 MΩ		
250 V (0 % to + 20 %)	0.1 to 60.0 MΩ	0.1 MΩ	1 mA @ 250 kΩ	± (1.5 % + 5 counts)
	60 to 250 MΩ	1 MΩ		
500 V (0 % to + 20 %)	0.1 to 60.0 MΩ	0.1 MΩ	1 mA @ 500 kΩ	± (1.5 % + 5 counts)
	60 to 500 MΩ	1 MΩ		
1000 V (0 % to + 20 %)	0.1 to 60.0 MΩ	0.1 MΩ	1 mA @ 1 MΩ	± (1.5 % + 5 counts)
	60 to 600 MΩ	1 MΩ		± (10 % + 3 counts)
	0.6 to 2.0 GΩ	100 MΩ		

Model 1577

Output Voltage	Display Range	Resolution	Test Current	Resistance Accuracy ± (% of Rdg + Digits)
500 V (0 % to + 20 %)	0.1 to 60.0 MΩ	0.1 MΩ	1 mA @ 500 kΩ	± (2.0 % + 5 counts)
	60 to 500 MΩ	1 MΩ		
1000 V (0 % to + 20 %)	0.1 to 60.0 MΩ	0.1 MΩ	1 mA @ 1 MΩ	± (2.0 % + 5 counts)

Model 1587T

Output Voltage	Display Range	Resolution	Test Current	Resistance Accuracy ± (% of Rdg + Digits)
50 V (0 % to + 20 %)	0.01 to 6.00 MΩ	0.01 MΩ	1 mA @ 50 kΩ	± (3 % + 5 counts)
	6.0 to 50.0 MΩ	0.1 MΩ		
100 V (0 % to + 20 %)	0.01 to 6.00 MΩ	0.01 MΩ	1 mA @ 100 kΩ	± (3 % + 5 counts)
	6.0 to 60.0 MΩ	0.1 MΩ		
	60 to 100 MΩ	1 MΩ		