

03321E00

Coupler Sockets Series 8570/16, 8571/16

- For use in
 - Zone 1 and Zone 2
 - Zone 21 and Zone 22
- Available versions
 - 16 A: 8570/16
 - 32 A: 8571/16
- Carrier
 - made of stainless steel
 - with large carrying handle
 - with feet for free positioning
- With integrated switched socket

Coupler sockets 8570/16 and 8571/16 are used for extension cables between sockets and electrical equipment.







STAHL

Technical Data

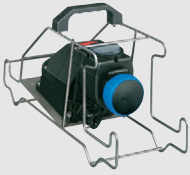
	8570/16	8571/16
Coupler sockets	8570/16	8571/16
Explosion protection		
Gas explosion protection	⊕ II 2 G EEx ed IIC T6	⊕ II 2 G EEx ed IIC T6
Dust explosion protection	⊕ II 2 D IP 66 T80 °C	⊕ II 2 D IP 66 T80 °C
Certificates	PTB 03 ATEX 1227	PTB 04 ATEX 1060
Material		
Socket	Polyamide	Polyamide
Carrier	Stainless steel	Stainless steel
Rated voltage	max. 690 V	max. 690 V
Rated current	16 A	32 A
Ambient temperature	- 20 °C ... + 40 °C - 50 °C ... + 55 °C on request	- 20 °C ... + 40 °C - 50 °C ... + 55 °C on request
Number of pins	1 P + N + ⚬, 3 P + ⚬, 3 P + N + ⚬	3 P + ⚬, 3 P + N + ⚬
Further technical data	see socket 8570/11 table Technical Data	see socket 8571/11 table Technical Data
Cable glands	13 mm ... 18 mm outer diameter	18 mm ... 25 mm outer diameter

Zones 1 & 2, 21 & 22

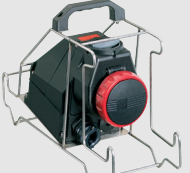
Selection table

Version	Number of pins	Voltage [V]	Colour	Frequency [Hz]	h	Ordering code	Weight kg
Coupler socket 16 A 	 06190E00 3 P (2 P + 1/2)	100 - 130	yellow	50/60	4	8570/16-304	2,100
		200 - 250	blue	50/60	6	8570/16-306	2,100
	 06556E00 4 P (3 P + 1/2)	380 - 415	red	50/60	6	8570/16-406	2,350
		480 - 500	black	50/60	7	8570/16-407	2,350
		600 - 690	black	50/60	5	8570/16-405	2,350
	 06555E00 5 P (3 P + N + 1/2)	200/346 - 240/415	red	50/60	6	8570/16-506	2,450
		277/480 - 288/500	black	50/60	7	8570/16-507	2,450
		347/600 - 400/690	black	50/60	5	8570/16-505	2,450
	Coupler socket 32 A 	 06556E00 4 P (3 P + 1/2)	380 - 415	red	50/60	6	8571/16-406
480 - 500			black	50/60	7	8571/16-407	3,100
600 - 690			black	50/60	5	8571/16-405	3,100
 06555E00 5 P (3 P + N + 1/2)		200/346 - 240/415	red	50/60	6	8571/16-506	3,350
		277/480 - 288/500	black	50/60	7	8571/16-507	3,350
		347/600 - 400/690	black	50/60	5	8571/16-505	3,350

Note Versions with other voltages and frequencies on request

Dimension drawings (all dimensions in mm) - subject to alterations

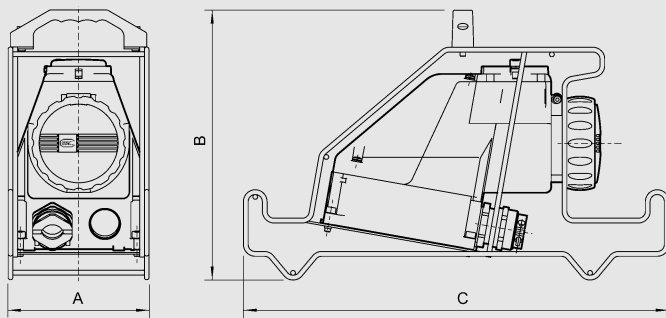

Type	A	B	C
8570/16 (16 A)	149	249	415
8571/16 (32 A)	149	284	450

857./16-... Coupler socket

We reserve the right to make alterations to the technical data, weights, dimensions, designs and products available without notice. The illustrations cannot be considered binding.

