

E-M-HC2-accessories_21 <small>Document code</small>	Rotronic AG Bassersdorf, Switzerland <small>Unit</small>
Accessories and Parts for probes, indicators and transmitters <small>Document title</small>	<div style="text-align: right;"> Instruction Manual <small>Document Type</small> </div> <hr/> <div style="text-align: right;"> Page 1 of 22 </div>

Accessories and Parts for probes, indicators and transmitters



E-M-HC2-accessories_21	Rotronic AG Bassersdorf, Switzerland
Document code	Unit
Accessories and Parts for probes, indicators and transmitters	Instruction Manual
	Document Type
Document title	Page 2 of 22

Table of contents

1	Configuration and communication software	3
2	Service cables for transmitters and indicators.....	3
3	Supply voltage adapters for the HC2 probes.....	4
4	Extension cables for the HC2 probes.....	5
4.1	Standard passive cables	5
4.2	Passive cables and connectors for OEM applications	6
4.3	Cables with digital signal booster	7
5	Digital interface adapters for the HC2 probes	8
5.1	USB adapter	8
5.2	RS-232 adapter	8
5.3	Ethernet adapter.....	8
5.4	RS-485 and Modbus adapters.....	9
6	Digital interface adapter for the HC2-S3C0 probe	11
6.1	USB adapter	11
7	USB / RS-485 converter	12
7.1	Powering the networked devices from the RS-485 main data line.....	13
7.2	RS-485 network design and installation	14
8	Ethernet / RS-485 converter	14
8.1	RJ-45 Connector and terminal blocks.....	15
8.2	Powering the networked devices from the RS-485 main data line.....	16
8.3	RS-485 network design and installation	17
8.4	Dimensional drawings	17
9	Mounting hardware	18
9.1	Mounting hardware for through-wall probe installation	18
9.2	Mounting hardware for transmitter enclosure	19
10	Calibration accessories	19
11	Dust filters	20
11.1	Spare filters	20
11.2	Dust filter parts	21
12	Maximum temperature limit for connectors, cables and adapters	22
13	Document releases	22

E-M-HC2-accessories_21	Rotronic AG Bassersdorf, Switzerland
Document code	Unit
Accessories and Parts for probes, indicators and transmitters	Instruction Manual
Document title	Document Type
	Page 3 of 22



1 Configuration and communication software

The ROTRONIC HW4 software (version 2.1.0 or higher) allows configuring the AirChip 3000 probes and instruments.

HW4 is compatible with Windows XP, Vista and NT4 with SP6a or higher. For more details see separate instruction manual provided with the software.

Order Code	Description
HW4-E	HW4 software, Standard Edition (single user)
HW4-P	HW4 Professional Edition, ERES regulations compliant (FDA / GAMP), multi user

2 Service cables for transmitters and indicators

Order Code	Description	
AC3006	Mini-USB service connector (UART) to a PC USB port. Cable electronics convert UART interface to USB interface. Approximate length: 1.7 m	
AC2001	Mini-USB service connector (UART) to 7-pin probe connector of the HP23 hand-held calibrator or other instrument with display and keypad. Approximate length: 1.7 m	

Notes:

- The active electronic circuit of cable AC3006 is powered directly from the USB port (PC or hub). Both the AC3006 and AC2001 do not provide power to the transmitter or indicator and these must be powered separately.
- Prior to using cable AC3006 the ROTRONIC USB driver must be installed on the PC (available from the HW4 CD or from www.rotronic-humidity.com). For installation instructions see document **E-M-HW4v2-Main** (§ 6.3).

E-M-HC2-accessories_21	Rotronic AG Bassersdorf, Switzerland
Document code	Unit
Accessories and Parts for probes, indicators and transmitters	Instruction Manual
Document title	Document Type
	Page 4 of 22

3 Supply voltage adapters for the HC2 probes

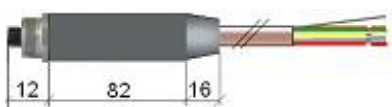
Order Code	Description	
E2-01XX-ACT	Female connector (black) with built-in voltage regulator for HC2 probes. 1 m (3.2 ft) cable with tinned ends	 <p>See: Wiring color code</p>
E2-02XX-ACT	Same as E2-01XX-ACT with 2m (6.5 ft) cable	
E2-05XX-ACT	Same as E2-01XX-ACT with 5m (16.4 ft) cable	
E3-01XX-ACT	Female connector (white) with built-in voltage regulator for HC2 probes. 1 m (3.2 ft) cable with tinned ends	
E3-02XX-ACT	Same as E3-01XX-ACT with 2m (6.5 ft) cable	
E3-05XX-ACT	Same as E3-01XX-ACT with 5m (16.4 ft) cable	

Specifications	
Supply voltage to adapter	5...24 VDC / 5...16 VAC
Supply voltage to probe	3.3 VDC
Current consumption (includes HC2 probe)	< 4 mA

Wire color	Name	Function
Green	VDD (+)	VDC + or VAC Phase
Grey	GND	Power ground and digital signal ground
Red	RXD	UART
Blue	TXD	UART
White	Out 1 analog (+)	Humidity: 0...1 V = 0...100%RH (default) or calculated parameter
Brown	Out 2 analog (+)	Temperature : 0...1V = -40...60°C (default)
Yellow	AGND (-)	Analog signal ground

Shielded cables with tinned ends: the shield is ended as a non-insulated wire connected to GND at the connector level

E-M-HC2-accessories_21	Rotronic AG Bassersdorf, Switzerland
Document code	Unit
Accessories and Parts for probes, indicators and transmitters	Instruction Manual
	Document Type
Document title	Page 5 of 22

NOTES:

- The electronic circuit of the adapter generates a small amount of heat. For this reason, do not place the adapter directly under the probe. Depending on the application, using a passive cable to separate the adapter and the HC2-S or HC2-S3 probe is recommended to prevent heat transfer from the adapter to the probe and obtain the best measurement accuracy.
- See also: Maximum temperature limit for connectors, cables and adapters

4 Extension cables for the HC2 probes

4.1 Standard passive cables

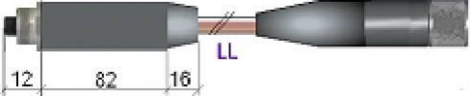
Order Code	Description	
E2-F3A	0.3 m (1 ft) extension cable (black) HC2 to instrument with standard 7-pin female / male connectors and wall mounting bracket for the HC2-S probe	
E3-F3A	Same as E2-F3A with white cable. Use with the HC2-S3 probe	
E2-01A	1 m (3.2 ft) extension cable (black) HC2 to instrument with standard 7-pin female / male connectors. Barrel length 82 mm (3.2")	
E3-01A	Same as E2-01A with white cable	
E2-02A	2 m (6.5 ft) extension cable (black) HC2 to instrument with standard 7-pin female / male connectors	
E3-02A	Same as E2-02A with white cable	
E2-05A	5 m (16.4 ft) extension cable (black) HC2 to instrument with standard 7-pin female / male connectors	
E3-05A	Same as E2-05A with white cable	

Order Code	Description	
E2-02AS	Same as E2-02A, but with short barrel	
E3-02AS	Same as E3-02A, but with short barrel	

NOTES:

- All white cables use PUR insulation (sunlight resistant)
- See also: Maximum temperature limit for connectors, cables and adapters

E-M-HC2-accessories_21	Rotronic AG Bassersdorf, Switzerland
Document code	Unit
Accessories and Parts for probes, indicators and transmitters	Instruction Manual
	Document Type
Document title	Page 6 of 22

4.2 Passive cables and connectors for OEM applications

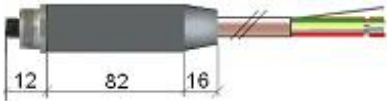
Order Code	Description	
E2-XX	Female connector for panel mount with 7 wires (0.3 m / 1ft), tinned ends	 <p>See: Wiring color code</p>
E2-01XX	Female connector (black), 1 m (3.2 ft) cable with tinned ends	 <p>See: Wiring color code</p>
E2-02XX	Same as E2-01XX with 2m (6.5 ft) cable	
E2-05XX	Same as E2-01XX with 5m (16.4 ft) cable	
E3-01XX	Female connector (white), 1 m (3.2 ft) cable with tinned ends	
E3-02XX	Same as E3-01XX with 2m (6.5 ft) cable	
E3-05XX	Same as E2-01XX with 5m (16.4 ft) cable	



See also: Maximum temperature limit for connectors, cables and adapters

Wire color	Name	Function
Green	VDD (+)	3.2 to 5 VDC
Grey	GND	Power and digital signal
Red	RXD	UART
Blue	TXD	UART
White	Out 1 analog (+)	Humidity 0...100%RH (default) or calculated parameter
Brown	Out 2 analog (+)	Temperature -40...60°C (default)
Yellow	AGND (-)	Analog signal ground

Shielded cables with tinned ends: the shield is ended as a non-insulated wire connected to GND at the connector level

E-M-HC2-accessories_21	Rotronic AG Bassersdorf, Switzerland
Document code	Unit
Accessories and Parts for probes, indicators and transmitters	Instruction Manual
Document title	Document Type
	Page 7 of 22

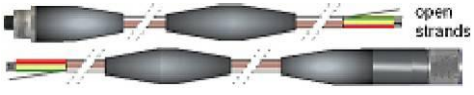
4.3 Cables with digital signal booster

Order Code	Description	
AC3003	<p>Active digital signal booster set</p> <p>Allows connecting a HC2 probe to a transmitter over a distance of up to 100 m (330 ft). The probe analog signals are not transmitted by the AC3003.</p> <p>Open strands with tinned ends designed for connection via two customer supplied terminal boxes. The strands are to be wired in parallel, e.g. 1:1</p> <p>Use a shielded cable with twisted pairs to connect the two terminal boxes.</p>	
AC3003-L	<p>Same as AC3003, but with long barrel on probe side.</p>	

Probe side

Transmitter side



max. 100 m / 330 ft

Wire color	Description
White	RS485_N_Tx
Blue	RS485_P_Tx
Brown	RS485_N_Rx
Red	RS485_P_Rx
Green	VDD (+) / 3.3 VDC
Gray	GND

NOTE:

- See also: Maximum temperature limit for connectors, cables and adapters

E-M-HC2-accessories_21 Document code	Rotronic AG Bassersdorf, Switzerland Unit
Accessories and Parts for probes, indicators and transmitters Document title	Instruction Manual Document Type Page 8 of 22

5 Digital interface adapters for the HC2 probes

NOTE:

- Supply voltage to the probe: 3.3 VDC \pm 0.1 VDC
- See also: Maximum temperature limit for connectors, cables and adapters

5.1 USB adapter

Order Code	Description	
AC3001	UART to USB adapter cable Connects HC2 probe to PC running HW4 Power is provided by USB port	

IMPORTANT:

- Prior to using cable AC3001, the ROTRONIC USB driver must be installed on the PC. Both the driver and the installation instructions (document **E-M-HW4v2-Main**) are located on the HW4 CD.

5.2 RS-232 adapter

Order Code	Description	
AC3002	UART to RS232 adapter cable Connects HC2 probe to PC running HW4 Requires AC adapter mod. AC1207 (9VDC)	

5.3 Ethernet adapter

Order Code	Description	
AC3005	UART to Ethernet (TCP/IP) adapter Connects HC2 probes to Ethernet network Power supply options: AC adapter mod. AC1207 (9VDC) or PoE (IEEE 802.3af compliant)	

IMPORTANT:

- Prior to using cable AC3005, the TCP/IP settings of the cable must be configured by the user to be compatible with the local area network. Detailed instructions are provided separately in documents **E-M-HW4v2-Main** and **E-M-TCPIP-Conf**. Devices with an Ethernet interface are shipped with a Device Configuration Certificate that provides information about the factory configuration settings.

E-M-HC2-accessories_21	Rotronic AG Bassersdorf, Switzerland
Document code	Unit
Accessories and Parts for probes, indicators and transmitters	Instruction Manual
Document title	Document Type
	Page 9 of 22

5.4 RS-485 and Modbus adapters

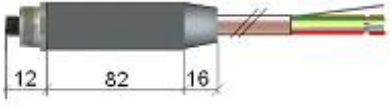
Order Code	Description	
E2-01XX-MOD	Female connector (black) for HC2 probes with 1 m (3.2 ft) cable (4 wires with tinned ends): Powers the HC2 probe and allows connecting the probe to either a RS-485 network or a Modbus network, depending on the communication protocol used by the probe See note below	
E2-02XX-MOD	Same as E2-01XX-MOD with 2m (6.5 ft) cable	
E2-05XX-MOD	Same as E2-01XX-MOD with 5m (16.4 ft) cable	

Specifications	
Supply voltage to adapter	5.0...28 VDC
Supply voltage to probe	3.3 VDC
Current consumption (includes HC2 probe)	10 mA typical
RS-485 specifications	Baud rate : 19200 Parity : none Data bits : 8 Stop bits : 1

Wire color	Name	Function
Green	VDD (+)	Power supply +
Grey	GND	Power and digital signal
Red	RXD	RS-485 bi-directional TX+ / RX +
Blue	TXD	RS-485 bi-directional TX- / RX -

NOTE: The electronic circuit of the adapter generates a small amount of heat. For this reason, do not place the adapter directly under the probe. Depending on the application, using a passive cable to separate the adapter and the HC2-S or HC2-S3 probe is recommended to prevent heat transfer from the adapter to the probe and obtain the best measurement accuracy.

E-M-HC2-accessories_21 Document code	Rotronic AG Bassersdorf, Switzerland Unit
Accessories and Parts for probes, indicators and transmitters Document title	<div style="text-align: right;"> Instruction Manual Document Type </div> <hr/> <div style="text-align: center;"> Page 10 of 22 </div>

Networking notes:

- A Modbus network and a RS-485 network are physically identical but cannot be mixed due to the difference between the communication protocols.
- The internal configuration of the HC2 probe determines which communication protocol (RO-ASCII or Modbus) will be used by the combination of probe and adapter. RO-ASCII is the factory default communication protocol for the HC2 probe and is automatically used whenever the probe is interrogated by the HW4 software.

The protocol used by the probe when not communicating with HW4 can be changed between RO-ASCII and Modbus with the HW4 software > Device Manager. After interrogating or configuring the probe with HW4, cycle power to the probe to enable the selected protocol.

- When connecting the probe to a RS-485 network be sure that the probe is configured to use the RO-ASCII protocol.
- RS-485 Compatibility: the RO-ASCII protocol is not compatible with the protocol used by the previous generation of ROTRONIC products. Do not connect legacy products and the adapter / HC2 probe combination to the same RS-485 multi-drop network.
- Within a RS-485 network, the combination of HC2 probe and adapter is always seen as a slave. The RS-485 address is that of the HC2 probe. The factory default is address 0. The master is another ROTRONIC device with an interface combination such as RS-485 and USB or RS-485 and TCP/IP.

Please note that each device connected to a RS-485 network, including the master device, must have a unique address. As long as the factory default address of the HC2 probe (0) has not been changed, the HW4 software will automatically change the address of the probe to the next available address at the time that the probe is added as a slave to a RS-485 network monitored by HW4.

The RS-485 address of the HC2 probe can also be changed manually with the HW4 software Device Manager.

- Each adapter can be powered either by an individual voltage source or centrally powered from the network with a single voltage source. In the case of a network that both provides power and transmits data, a shielded cable with two twisted pairs is required for the main bus.
- User to supply all necessary connecting hardware such as T-connection box, terminal box, etc.
- Prior to using the adapter, we strongly recommend consulting the following documents:
E-M-HW4v2-Main, E-M-HW4v2-F2-001 and E-M-AC3000-CP

E-M-HC2-accessories_21	Rotronic AG Bassersdorf, Switzerland
Document code	Unit
Accessories and Parts for probes, indicators and transmitters	Instruction Manual
Document title	Document Type
	Page 11 of 22

6 Digital interface adapter for the HC2-S3C0 probe

6.1 USB adapter

Order Code	Description	
AC3001-XX	<p>UART to USB adapter cable</p> <p>Connects HC2-S3C0 probe to PC running HW4 (this cable is supplied with a terminal block which allows connecting the probe)</p> <p>Power for the adapter electronics is provided by USB port</p> <p>Power to the probe must be supplied separately</p>	

IMPORTANT:

- Prior to using cable AC3001-XX, the ROTRONIC USB driver must be installed on the PC. Both the driver and the installation instructions (document **E-M-HW4v2-Main**) are located on the HW4 CD.

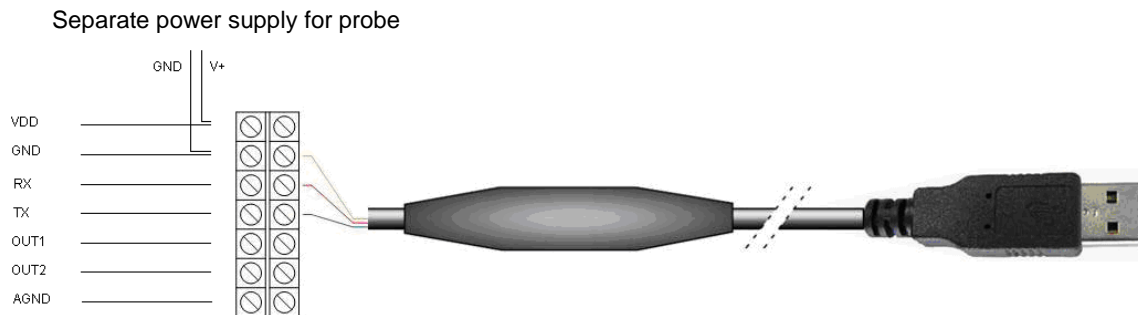

Note: the maximum cable length for transmitting the digital signal to and from the probe UART interface (RX and TX) is 5 meters.

E-M-HC2-accessories_21	Rotronic AG Bassersdorf, Switzerland
Document code	Unit
Accessories and Parts for probes, indicators and transmitters	Instruction Manual
	Document Type
Document title	Page 12 of 22

7 USB / RS-485 converter

Use the AC3010 converter with:

- HF45
- HF53 with digital option
- HF55
- HF65
- HF8 with RS-485 port

IMPORTANT:

- 1) Do not use the AC3010 with legacy devices or with the HygroLog HL-NT
- 2) Prior to using the AC3010, the ROTRONIC USB driver must be installed on the PC (available from the HW4 CD or from www.rotronic-humidity.com). For installation instructions see document **E-M-HW4v2-Main** (§ 6.3).

Order Code	Description
AC3010	<p>Allows connecting up to 64 RS-485 slave devices to a USB port. The AC3010 itself does not count as a device on the RS-485 network and does not have a RS-485 address.</p> <p>The AC3010 converter cable is powered directly from the USB port and does not require a power supply.</p> 

Wire color	Function
Red	TX+ / RX+ (RS-485 bidirectional)
Blue	TX- / RX- (RS-485 bidirectional)
Green	V+ (optional connection)
Drain (shield)	GND (optional connection)

E-M-HC2-accessories_21	Rotronic AG Bassersdorf, Switzerland
Document code	Unit
Accessories and Parts for probes, indicators and transmitters	Instruction Manual
Document title	Document Type
	Page 13 of 22

7.1 Powering the networked devices from the RS-485 main data line

Depending on the model, the devices connected to a RS-485 network can be powered from the main data line as opposed to each device being powered separately. Please check the instruction manual of each device.

The AC3010 offers the following options to power devices from the main data line:

a) Power directly from the USB port

Cable AC3010 has two wires (V+ and GND) that can be used to power the networked devices directly from the USB port (5 VDC, 100 mA). In addition to the limit of 100 mA, the length of the main data line should not exceed 100 m / 330 Ft.

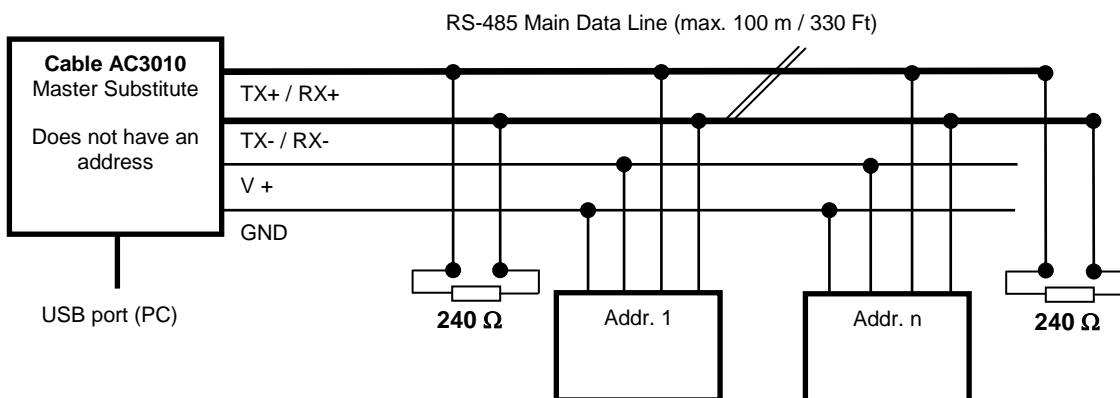

b) Power from a separate voltage source

When the networked devices are not powered from the USB port, the length of the main data line can be up to 1000 m / 3300 Ft.

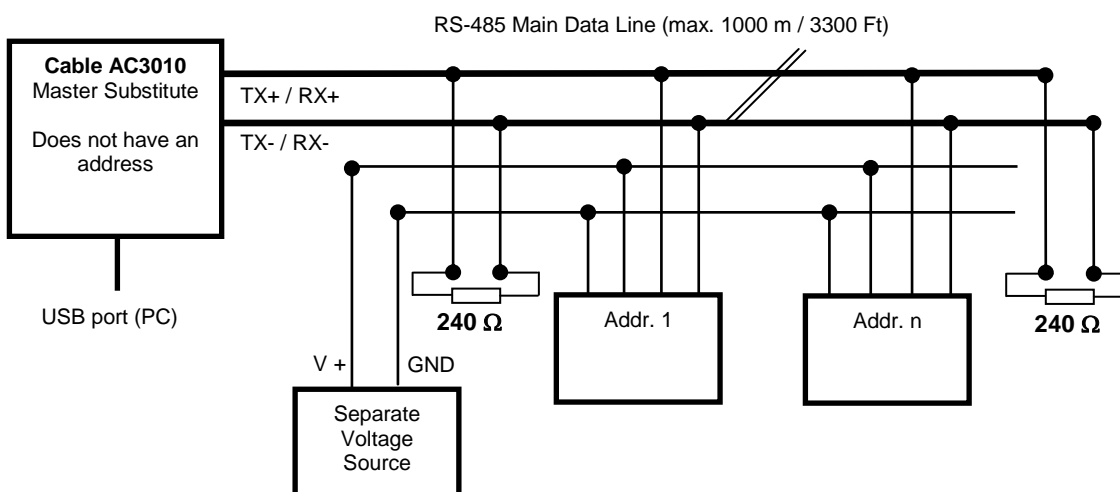

E-M-HC2-accessories_21	Rotronic AG Bassersdorf, Switzerland
Document code	Unit
Accessories and Parts for probes, indicators and transmitters	Instruction Manual
Document title	Document Type
	Page 14 of 22

7.2 RS-485 network design and installation

Please follow the instructions provided in document **E-DV04-RS485.01**

- Limit the RS-485 network to a single main data line (one segment)
- Terminate each end of the main data line with a 240 Ohm resistor. Termination resistors should be placed only at the extreme ends of the data line, and no more than two terminations should be placed in any single segment of an RS-485 network
- The total length the T connections should be included in the limit set for the main data line (100 m or 1000 m)
- Do not connect more than 64 devices to the same main data line
- Each device connected to the RS-485 network should be given a unique address (1 to 64)

8 Ethernet / RS-485 converter

Use with:

- Any AirChip 3000 device that has a RS-485 port
- Docking stations for the HygroLog HL-NT
- Any legacy device that has a RS-485 port

IMPORTANT:

- 1) Use of the AC3011 requires a PC with the HW4 software version 2.4.0 or higher. The HW4 software includes an Ethernet Configuration Tool that can be used to make the TCP/IP settings of the AC3011 converter compatible with the LAN to which the HW4 PC is connected. For additional information see documents **E-M-HW4v2-Main** (§ 6.4 and § 10.2) and **IN-E-TCPIP-Conf**.
- 2) The AC3011 converter allows mixing both AirChip 3000 and legacy devices within the same RS-485 network as long as all devices use the same Baud rate (19200)

Order Code	Description
AC3011	<p>Allows connecting up to 64 RS-485 slave devices to an Ethernet port (PC or LAN). The AC3011 has an IP address but no RS-485 address and does not count as one of the devices on the RS-485 network.</p> <p>The AC3011 converter requires a 12 to 24 VDC external power supply.</p>



E-M-HC2-accessories_21	Rotronic AG Bassersdorf, Switzerland
Document code	Unit
Accessories and Parts for probes, indicators and transmitters	Instruction Manual
	Document Type
Document title	Page 15 of 22

Specifications	
Supply voltage to AC3011 converter	12...24 VDC (can be used to power the RS-485 slave devices when mA rating is sufficient)
Current consumption (AC3011 only)	85 mA typical
Temperature operating range	-40...85°C
RS-485 specifications	Baud rate : 19200 Parity : none Data bits : 8 Stop bits : 1

8.1 RJ-45 Connector and terminal blocks

The RJ-45 connector is accessible without having to open the AC3011 enclosure.

Terminal Block K1 (Power)	Function
K1-1	GND: Supply voltage (-) to AC3011
K1-2	V + :Supply voltage (+) to AC3011 – 12 to 24 VDC
K1-3	Earth Ground : Safety ground

Terminal Block K3 (RS-485)	Function
K3-4	D - : TX- / RX- (RS-485 bidirectional)
K3-3	D +: TX+ / RX+ (RS-485 bidirectional)
K3-2	GND: Supply voltage (-) to RS-485 data line (optional)
K3-1	V + : Supply voltage (+) to RS-485 data line – 12 to 24 VDC (optional)

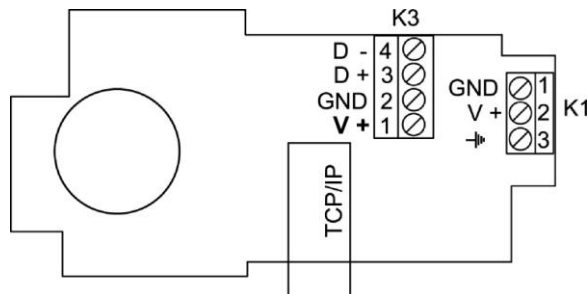

E-M-HC2-accessories_21	Rotronic AG Bassersdorf, Switzerland
Document code	Unit
Accessories and Parts for probes, indicators and transmitters	Instruction Manual
Document title	Document Type
	Page 16 of 22

8.2 Powering the networked devices from the RS-485 main data line

Depending on the model, the devices connected to a RS-485 network can be powered from the main data line as opposed to each device being powered separately. Please check the instruction manual of each device.

The AC3011 offers the following options to power devices from the main data line:

a) Power from the same source as the AC3011

This option can be used only when the mA rating of the power supply used for the AC3011 is sufficient to power both the AC3011 and the networked devices.

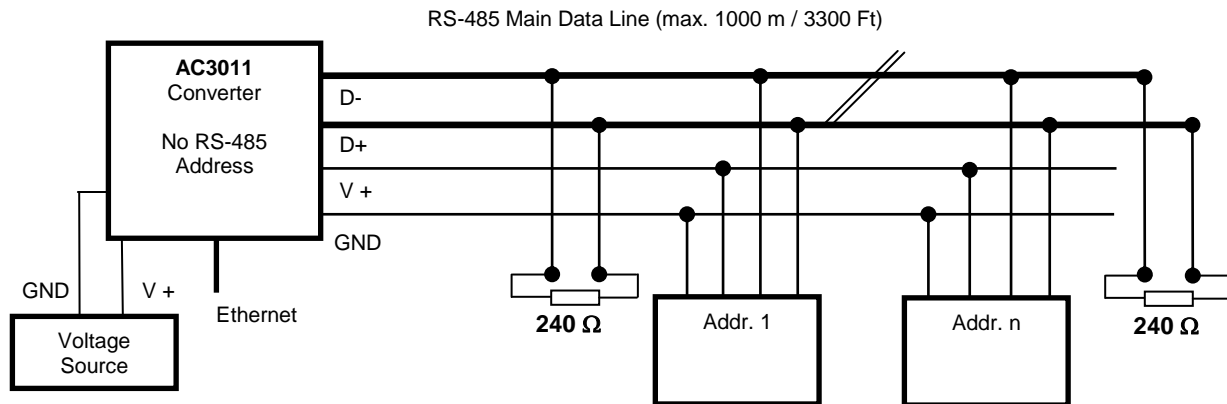

b) Power from a separate voltage source

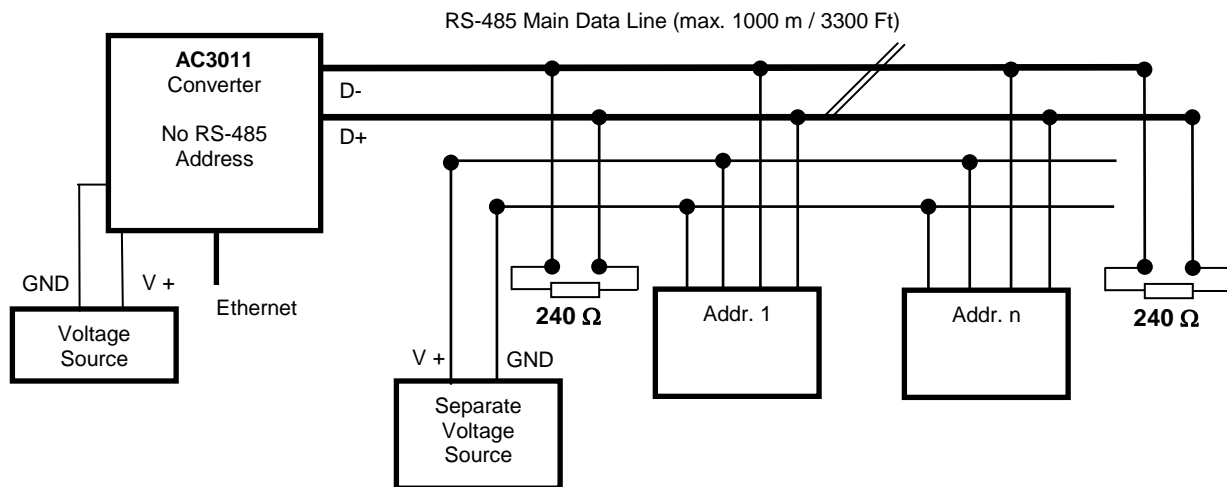

E-M-HC2-accessories_21	Rotronic AG Bassersdorf, Switzerland
Document code	Unit
Accessories and Parts for probes, indicators and transmitters	Instruction Manual
	Document Type
Document title	Page 17 of 22

8.3 RS-485 network design and installation

Please follow the instructions provided in document **E-DV04-RS485.01**

- Limit the RS-485 network to a single main data line (one segment)
- Terminate each end of the main data line with a 240 Ohm resistor. Termination resistors should be placed only at the extreme ends of the data line, and no more than two terminations should be placed in any single segment of an RS-485 network
- The total length the T connections should be included in the limit set for the main data line (100 m or 1000 m)
- Do not connect more than 64 devices to the same main data line
- Each device connected to the RS-485 network should be given a unique address (1 to 64)

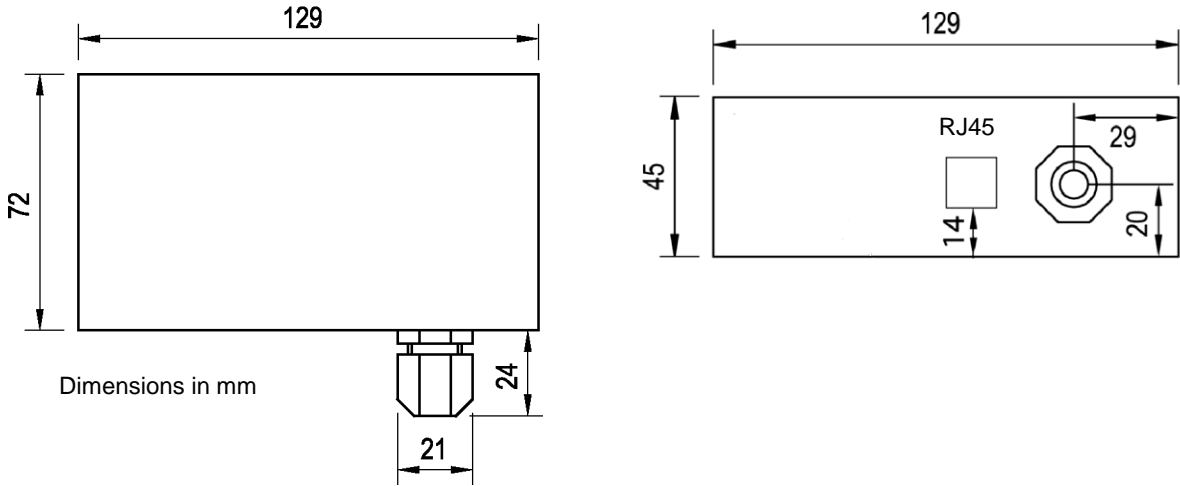

8.4 Dimensional drawings



E-M-HC2-accessories_21	Rotronic AG Bassersdorf, Switzerland
Document code	Unit
Accessories and Parts for probes, indicators and transmitters	Instruction Manual
	Document Type
Document title	Page 18 of 22

9 Mounting hardware

9.1 Mounting hardware for through-wall probe installation

Order Code	Description	
AC5005	<p>Mounting flange with compression fitting for (15 mm / 0.6" diameter probe).</p> <p>Use for though wall installation of the HF4 type D</p> <p>Maximum temperature 100 °C (212°F)</p>	
AC5001	<p>Sleeve for adapting a 15 mm / 0.6" diameter probe to a 25 mm / 1.0 " diameter through-wall mounting hole (HF42 and HF43 type D, vertical mounting position)</p> <p>Facilitates the replacement of older products with a 25 mm probe diameter</p>	

Order Code	Description	
AC1303-M	Compression fitting for 15 mm (1.0") diameter probes. Maximum temperature 200 °C (392°F)	
AC1304-M	Compression fitting for 25 mm (0.6") diameter probes. Maximum temperature 200 °C (392°F)	
AC1305	Flange for AC1303-M – nickel coated steel Diameter: 80 mm (3.1")	
AC1306	Flange for AC1304-M – nickel coated steel Diameter: 80 mm (3.1")	

E-M-HC2-accessories_21	Rotronic AG Bassersdorf, Switzerland
Document code	Unit
Accessories and Parts for probes, indicators and transmitters	Instruction Manual
Document title	Document Type
	Page 19 of 22

9.2 Mounting hardware for transmitter enclosure

Use with:

- HF4
- HF5
- HF6

Order Code	Description	
AC5002	DIN-rail mounting kit consisting of 2 clamps that attach to the back of the enclosure with the screws provided. DIN-rail (35 mm / 1 3/8") not included	

10 Calibration accessories



Order Code	Description
EA00-SCS	0.5 %RH humidity std, SCS cert., pack of 5
EA05-SCS	5 %RH humidity std, SCS cert., pack of 5
EA10-SCS	10 %RH humidity std, SCS cert., pack of 5
EA20-SCS	20 %RH humidity std, SCS cert., pack of 5
EA35-SCS	35 %RH humidity std, SCS cert., pack of 5
EA50-SCS	50 %RH humidity std, SCS cert., pack of 5
EA65-SCS	65 %RH humidity std, SCS cert., pack of 5
EA80-SCS	80 %RH humidity std, SCS cert., pack of 5
EA95-SCS	95 %RH humidity std, SCS cert., pack of 5
ER-15	Calibration device for 15mm diameter probes
ER-05	Calibration device for 5mm diameter probes
EM-G	Calibration device for type 'IE' probes

For instructions regarding the ROTRONIC humidity standards and calibration devices see document **E-M-CalBasics**.

E-M-HC2-accessories_21	Rotronic AG Bassersdorf, Switzerland
Document code	Unit
Accessories and Parts for probes, indicators and transmitters	Instruction Manual
	Document Type
Document title	Page 20 of 22

11 Dust filters

11.1 Spare filters

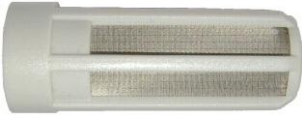



Order Code	Use with	Slotted cap	Filter insert	
NSP-PCB-PE	HC2-S HF4 HF6 wall mount HP21	Polycarbonate, black	Polyethylene	
NSP-PCB-WM			Wire mesh	
NSP-PCB-TF			Teflon	
NSP-PCW-PE	HC2-S3	Polycarbonate, white	Polyethylene	
NSP-PCW-WM			Wire mesh	
NSP-PCW-TF			Teflon	
NSP-PCG-PE	HF3	Polycarbonate, grey	Polyethylene	
NSP-PCG-WM			Wire mesh	
NSP-PCG-TF			Teflon	

Order Code	Use with	Filter Material	
ET-Z10	HC2-HP28 HC2-HP50	Sintered steel	

Order Code	Use with	Description	
SP-T05	H2C-C05	Teflon filter	

E-M-HC2-accessories_21	Rotronic AG Bassersdorf, Switzerland
Document code	Unit
Accessories and Parts for probes, indicators and transmitters	Instruction Manual
	Document Type
Document title	Page 21 of 22

11.2 Dust filter parts

Order Code	Use with	Description	
NSP-ME	HC2-HK HC2-HP HC2-IC HF6 duct / cable	Filter base Nickel plated brass HC2 thread Filter Cartridge not included	
SP-MSB15	HC2-IM HC2-IE HF7	Filter base Nickel plated brass HC1 thread Filter Cartridge not included	
SP-M15	NSP-ME SP-MSB15	Wire mesh filter cartridge Use with NSP-ME or SP-MSB15	
SP-S15	NSP-ME SP-MSB15	Sintered steel filter cartridge Use with NSP-ME or SP-MSB15	
SP-T15	NSP-ME SP-MSB15	Teflon filter cartridge Use with NSP-ME or SP-MSB15	

E-M-HC2-accessories_21	Rotronic AG Bassersdorf, Switzerland
Document code	Unit
Accessories and Parts for probes, indicators and transmitters	Instruction Manual
Document title	Document Type
	Page 22 of 22

12 Maximum temperature limit for connectors, cables and adapters

- Cables and wiring: 70°C (158°F)
- All probe side connectors: 100 °C (212 °F)
- All other connectors (USB, mini-USB, D-Sub 9 or RJ45: 70°C (158°F)

NOTES:

- Probe side connectors have a maximum temperature limit of 100 °C so as to permit full immersion of the HC2-S probe into a hot environment. However the cable itself should not be subjected to temperature higher than 70 °C.
- Operating temperature limits of all electronic circuits used for cables and adapters: -40...85 °C (-40...185 °F)

13 Document releases

Doc. Release	Date	Notes
_20	Apr.11, 2009	Original release
_21	Feb. 23, 2010	Added AC3011 converter and AC3001-XX UART to USB adapter cable