

DART MODEL PD602 LOW-COST PROCESS METER



SPECIFICATIONS

Except where noted all specifications apply to operation at +25°C.

General

Inputs: Field selectable: 4-20 mA, 0-5 V, 1-5 V, 0-10 V

Display: 0.56" (14.2 mm) red LED, 3½ digits (±1999)

Accuracy: ±0.05% FS ±1 count

Calibration Range: Low input (e.g. 4 mA): -500 to 500

High input (e.g. 20 mA): 20 to 2000 above low input display.

Decimal Point: Jumper selectable up to three decimal places

Front Panel: NEMA 4X, IP65; panel gasket provided

Input Impedance: Voltage ranges: greater than 200 kΩ;

Current range: 10-60 Ω, varies with resettable fuse impedance

Input Overload: Protected by automatically resettable fuse

Display Update Rate: 2.5/second

Overrange: Displays 1

Underrange: Displays -1

Temperature Drift: 100 PPM/°C

Recalibration: Recommended at least every 12 months

Power Options: 85-265 VAC, 50/60 Hz, 90-265 VDC, 8 W max or 12-36 VDC, 12-24 VAC, 6 W max.

Transmitter Supply: Isolated 24 VDC ±10% @ 200 mA max

Required Fuse: UL Recognized, 5 A max, slow-blow; up to 6 meters may share one fuse.

Normal Mode Rejection: 62 dB at 50/60 Hz

Common Mode Rejection: 120 dB at 50/60 Hz

Isolation: 4 kV input-to-power line; 500 V input-to-24 VDC supply

Operating Temperature: 0 to 65°C

Storage Temperature: -40 to 85°C

Relative Humidity: 0 to 90% non-condensing

Connections: Removable screw terminals accept 12 to 26 AWG

Enclosure: 1/8 DIN, high impact plastic, UL 94V-0, color: gray

Weight: 5.0 oz (142 g)

Warranty: 1 year parts & labor

Extended Warranty: 1 or 2 years, refer to Price List for details.

MOUNTING DIMENSIONS

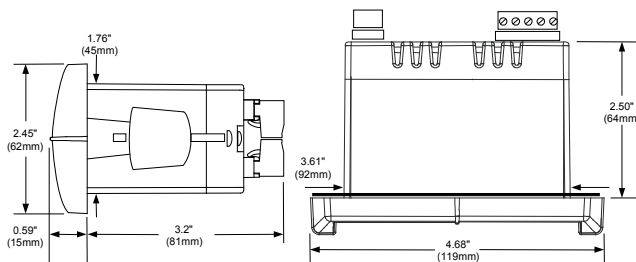

Features & Benefits

- 4-20 mA, 0-5 V, 1-5 V, 0-10 V inputs
- NEMA 4X front panel with protective overlay
- Calibrate from the front panel
- Easy to set up and calibrate
- Universal power supply
- 12-36 VDC power option
- 24 VDC @ 200 mA supply option

Panel Mounting Instructions

1. Remove the two mounting brackets provided with the meter (back-off the two screws so that there is ¼" (6.4 mm) or less through the bracket. Slide the bracket toward the front of the case and remove).
2. Insert meter into the panel cutout.
3. Install mounting brackets and tighten the screws against the panel. To achieve a proper seal, tighten the mounting bracket screws evenly until meter is snug to the panel along its short side.

DO NOT OVER TIGHTEN.

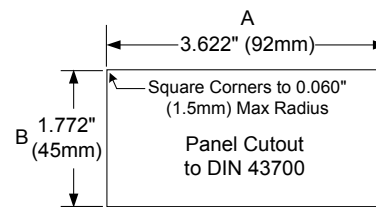

Tolerances:
 A: +0.032 (+0.8mm)
 -0.000 (-0.0mm)
 B: +0.024 (+0.6mm)
 -0.000 (-0.0mm)

ORDERING INFORMATION

Dart Model PD602		
85-265 VAC** Model	12-36 VDC** Model	Options Installed
PD602-6R0-0*	PD602-7R0-0	None
PD602-6R0-1*		24 VDC Transmitter Supply

*Quick Shipment Program product, shipped within 2 working days.
 **Meters may be powered from AC or DC, see Specifications for details.

Setup, Calibration & Labels

Model	Description
PDN-CAL	2-Point Input Calibration
PDN-CERTCAL	Certificate of Calibration
PDN-CERTCAL2	Certificate of Calibration with Data
PDLXXXX	Engraved Plastic Labels

DART MODEL PD602 LOW-COST PROCESS METER

SAFETY INFORMATION



CAUTION: Read complete instructions prior to installation and operation of the meter.



WARNING: Risk of electric shock. Observe all safety regulations. Electrical wiring should be performed in accordance with all applicable national, state, and local codes to prevent damage to the meter and ensure personnel safety.



WARNING: Hazardous voltages exist within enclosure. Only trained service personnel should perform installation and service.

SETUP

All operations are performed with the meter in the case.

Input Signal & Decimal Point Selection

The input signal and the decimal point are selected by the jumper array located at the rear of the meter, next to the signal connector. The label affixed to the case shows the jumper location and configuration for the selected input signal.

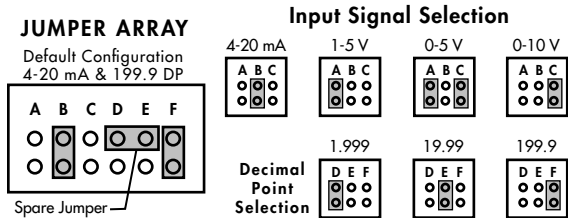

Connections

All connections are made to removable screw terminal connectors located at the rear of the meter. The label affixed to the case shows the location of all connectors available with requested configuration.

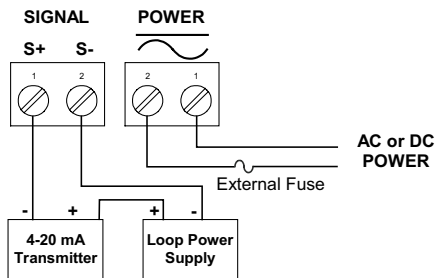

**Meter powered from universal supply
Transmitter powered by external power supply**

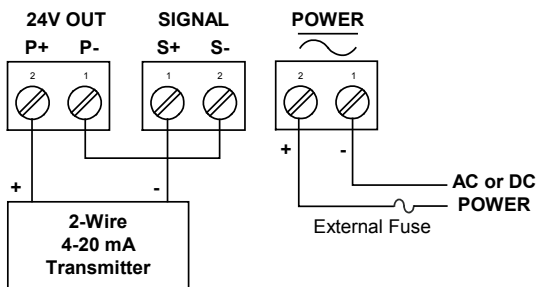

**Meter powered from universal supply
Transmitter powered by internal power supply (optional)**

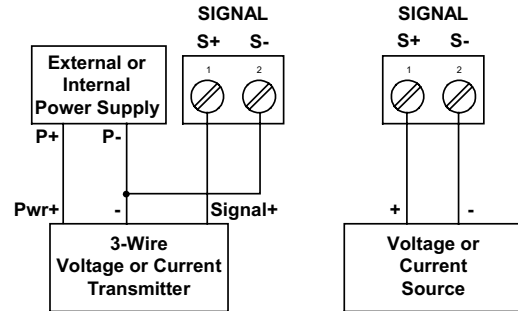

Three-wire transmitter & voltage or current source connections

Front Panel Calibration Controls

The LO and HI calibration controls are located behind the faceplate. The calibration controls may be reached through an access-hole on the faceplate. After the calibration has been completed, use the overlay provided to cover the access-hole to maintain NEMA 4X protection.

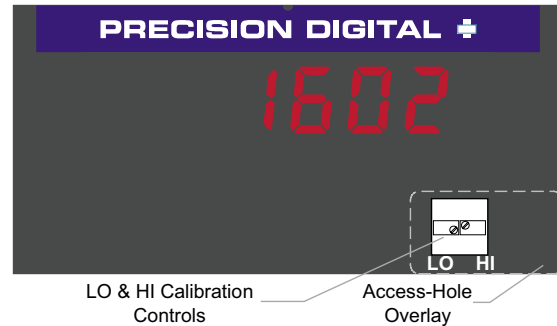

1. Apply low input signal (e.g. 4 mA) and adjust the LO calibration control for desired display reading.
2. Apply high input signal (e.g. 20 mA) and adjust the HI calibration control for desired display reading.
3. Complete the calibration by making any minor adjustments to the LO and HI displays.
4. Remove adhesive backing from the overlay provided and apply to the faceplate to cover the access-hole for the calibration controls.

Three access-hole overlays are provided with each meter. When recalibrating the meter, use a new overlay to maintain NEMA 4X protection.

LIM602_C 06/05