

<b>E-M-HF5-V1_25</b> Document code	Rotronic AG Bassersdorf, Switzerland Unit
<b>HygroFlex HF5 Humidity Temperature Transmitters: User Guide</b> Document title	<b>Instruction Manual</b> Document Type Page 1 of 30

# HygroFlex HF5 Humidity Temperature Transmitters

## User Guide



<b>E-M-HF5-V1_25</b> Document code	Rotronic AG Bassersdorf, Switzerland Unit
<b>HygroFlex HF5 Humidity Temperature Transmitters: User Guide</b> Document title	<b>Instruction Manual</b> Document Type Page 2 of 30

## Table of contents

<b>1</b>	<b>Overview .....</b>	<b>3</b>
<b>2</b>	<b>Mechanical configurations and dimensions .....</b>	<b>4</b>
2.1	Display and keypad option .....	5
<b>3</b>	<b>General description .....</b>	<b>5</b>
3.1	Power supply options .....	5
3.2	Measured parameters .....	6
3.3	Calculated parameters .....	6
3.4	Analog output signals (HF52 and HF53) .....	6
3.5	Digital interface (HF53 with digital option and HF55) .....	7
3.6	Service connector .....	7
3.7	Probe .....	7
<b>4</b>	<b>User configurable settings and functions .....</b>	<b>7</b>
4.1	Function overview .....	8
4.2	Interaction between the HF5 and probe functions .....	9
4.3	HF53 output signal type .....	11
<b>5</b>	<b>Mechanical installation .....</b>	<b>12</b>
5.1	General guidelines .....	12
5.2	HF5 enclosure .....	12
5.3	Installation of the HF5 type D (through wall mount) .....	13
5.4	Installation of the HF5 type W (surface mount) .....	13
<b>6</b>	<b>Electrical installation .....</b>	<b>14</b>
6.1	General wiring guidelines .....	14
6.2	Guidelines for RS-485 wiring (HF53 with digital option and HF55) .....	15
6.3	Cable grip and cable specifications .....	15
6.4	Wiring .....	16
<b>7</b>	<b>Operation .....</b>	<b>21</b>
7.1	HF52 and HF53 transmitters (analog outputs) .....	21
7.2	HF53 with digital option and HF55 .....	21
7.3	Internal menu (optional keypad and display) .....	22
7.4	Displayed parameters (optional keypad and display) .....	24
<b>8</b>	<b>Maintenance .....</b>	<b>24</b>
8.1	Service cable .....	24
8.2	Location of the service connector (mini USB type) .....	24
8.3	Periodic calibration check of the probe .....	24
8.4	Cleaning or replacing the probe dust filter .....	26
8.5	Validation of the output signals transmission .....	26
<b>9</b>	<b>Firmware updates .....</b>	<b>26</b>
<b>10</b>	<b>Technical data .....</b>	<b>27</b>
10.1	Specifications .....	27
10.2	Dew point accuracy .....	29
<b>11</b>	<b>Accessories .....</b>	<b>29</b>
<b>12</b>	<b>Supporting documents .....</b>	<b>29</b>
<b>13</b>	<b>Document releases .....</b>	<b>30</b>

<b>E-M-HF5-V1_25</b> Document code	Rotronic AG Bassersdorf, Switzerland Unit
<b>HygroFlex HF5 Humidity Temperature Transmitters: User Guide</b> Document title	<b>Instruction Manual</b> Document Type
	Page 3 of 30

## Applicability:

This manual applies to all instruments of the HygroFlex HF5 series with firmware version 1.x, where 1.x can be 1.0, 1.1, etc. Changes to the last digit of the version number reflect minor firmware changes that do not affect the manner in which the instrument should be operated.

## 1 Overview

The HygroFlex HF5 transmitter series is designed for fixed installation in applications where high measurement accuracy is required and can be used with any of the HygroClip 2 plug-in probes. The most basic HF5 models provide analog output signals corresponding to any two of the following: relative humidity, temperature or calculated value such as dew point, enthalpy, mixing ratio, etc. Other models provide either a digital interface and two analog output signals or a just a digital interface. The digital interface allows the simultaneous reading of relative humidity, temperature and calculated value. Depending on the probe model, the HF5 can measure conditions within the range of 0 to 100 %RH and -100 to 200°C (-148 to 392°F).

The wide assortment of HygroClip 2 humidity-temperature probes can meet almost any application requirement. The HygroClip 2 probes feature well proven, durable sensors. Digital signal processing within the probe ensures consistent product performance and also facilitates the task of field maintenance with features such as potentiometer free – digital calibration, hot-swapping of the probe, etc.

Based on the ROTRONIC AirChip 3000 digital technology the HF5 series and HygroClip 2 probes offer the following user functions:

- User configurable settings
- Calculation of psychrometric parameters such as the dew or frost point
- Humidity temperature calibration and adjustment <sup>1)</sup>
- Simulator mode
- Automatic humidity sensor test and drift compensation <sup>1)</sup>
- Sensor failure mode <sup>1)</sup>
- Data recording <sup>1)</sup>

1) Except model HF52 (2-wire transmitter)

The ability for the user to easily update both the HF5 and HygroClip 2 probe firmware means that instruments of the HF5 series can be kept up-to-date regarding any future functionality improvement.

**HF5 transmitters with analog output signals and optional digital output:** two types of electronic circuit are available: HF52: 2-wire, loop powered circuit (4...20 mA current signal) and HF53: 3-wire circuit with voltage or current signals. Both circuit types provide linear analog signals for transmission over a length of cable to a remote display, recorder, controller or data processing unit and can be used to measure humidity only, temperature only or both parameters. The HF53 (3-wire circuit type) can be ordered with two analog outputs and either a RS-485 port or USB + RS-485.

**HF5 transmitters with digital output only:** the HF55 is available with the following digital interface options: RS-485, USB + RS-485 or Ethernet (TCP/IP) + RS-485.

<b>E-M-HF5-V1_25</b>	Rotronic AG Bassersdorf, Switzerland
Document code	Unit
<b>HygroFlex HF5 Humidity Temperature Transmitters: User Guide</b>	<b>Instruction Manual</b>
	Document Type
Document title	Page 4 of 30

## 2 Mechanical configurations and dimensions

### Type D: duct mount (vertical)

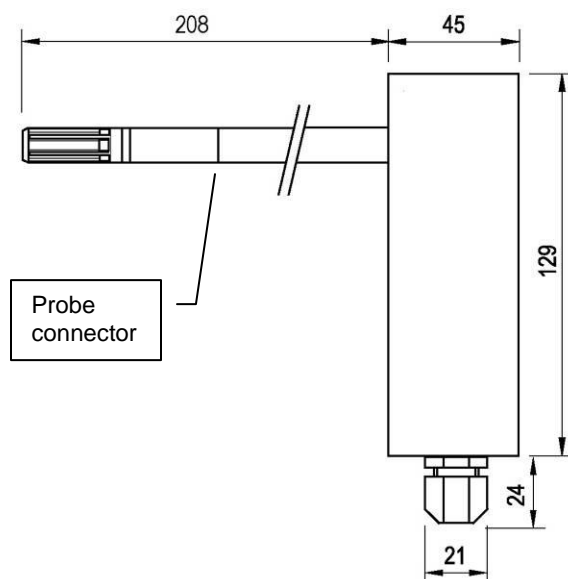

### Type W: wall mount (horizontal)

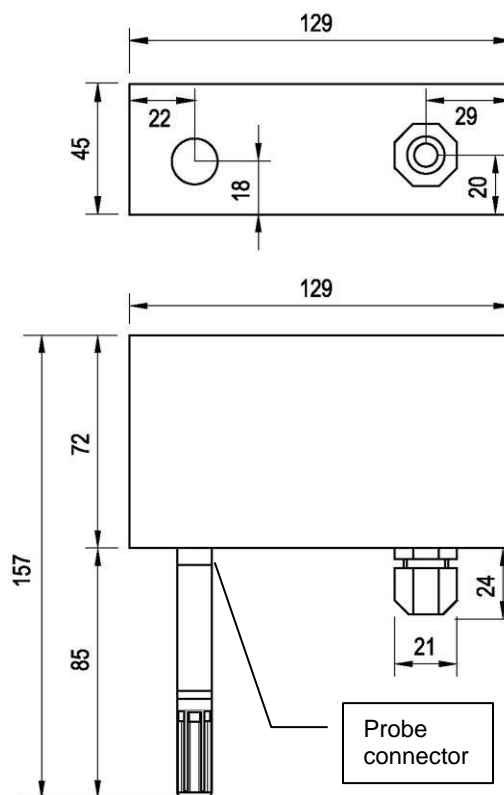

Dimensions in mm

#### NOTE:

#### Vertical mounting applies only to:

- HF52 type D without keypad and display
- HF53 type D without keypad and display, and without digital option

All other models are mounted horizontally

#### Models with USB or Ethernet interface

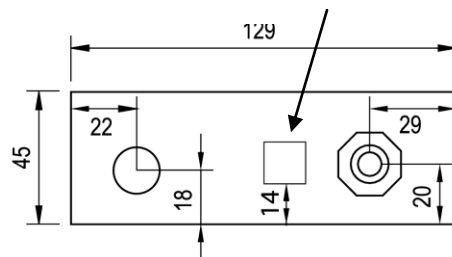

<b>E-M-HF5-V1_25</b> Document code	Rotronic AG Bassersdorf, Switzerland Unit
<b>HygroFlex HF5 Humidity Temperature Transmitters: User Guide</b> Document title	<b>Instruction Manual</b> Document Type Page 5 of 30

## 2.1 Display and keypad option



The LC display option for the HF53 and HF55 has a backlight. The LC display option for the HF52 does not have a backlight.

The upper line corresponds to relative humidity or dew / frost point and the bottom line corresponds to temperature.

The display can be configured to show a trend indicator on each line:

- ▲: increasing value
- ▼: decreasing value

In the event of an alarm the display shows the symbol [ ! ] to the right of the value.

For instructions see the following HW4 manual: **E-M-HW4v3-F2-005**.

## 3 General description

### 3.1 Power supply options

Depending on the circuit type, the HF5 requires the following power supply:

- a) **HF52** (2-wire, loop powered): 10...28 VDC - depending on the load connected to the output(s). The minimum supply voltage can be determined as follows:

$$V_{\min} = 10 \text{ V} + (0.02 \times \text{Load}^*) \quad * \text{Load resistance in ohms.}$$

For the maximum load of 500 Ω, the minimum supply voltage is 10 + (0.02 x 500) = 20 VDC. With both output circuits closed, the maximum current consumption is 40 mA.

- b) **HF53** (3-wire with analog outputs):

- Option 1, standard power supply: 15 to 40 VDC or 12 to 28 VAC
- Option 2: galvanically isolated power supply: 9 to 36 VDC or 7 to 24 VAC

With both output circuits closed, the typical current consumption is 100 mA.

Please verify the product identification label to determine which power supply option is installed on your transmitter.

- c) **HF55** (3-wire) with digital outputs:

- Option 1, standard power supply: 5 to 40 VDC or 12 to 28 VAC
- Option 2: galvanically isolated power supply: 9 to 36 VDC or 7 to 24 VAC
- Option 3: PoE (power over Ethernet). This option is not available with units equipped with a RS-485 interface. Any unit equipped with the PoE option can be powered only via a LAN.

<b>E-M-HF5-V1_25</b> Document code	Rotronic AG Bassersdorf, Switzerland Unit
<b>HygroFlex HF5 Humidity Temperature Transmitters: User Guide</b> Document title	<b>Instruction Manual</b> Document Type Page 6 of 30

Typical current consumption:

Model with USB interface : 100 mA  
Model with Ethernet (TCP/IP) interface: 300 mA

### 3.2 Measured parameters

The HygroClip 2 probe used with the HF5 transmitter measures relative humidity with a ROTRONIC Hygromer® IN1 capacitive sensor and temperature with a Pt100 RTD.

### 3.3 Calculated parameters

Using the ROTRONIC HW4 software, the HF5 can be configured by the user to calculate one of the following parameters:

- Dew point (Dp) above and below freezing
- Frost point (Fp) below freezing and dew point above freezing
- Wet bulb temperature (Tw)
- Enthalpy (H)
- Vapor concentration (Dv)
- Specific humidity (Q)
- Mixing ratio by weight (R)
- Vapor concentration at saturation (Dvs)
- Vapor partial pressure (E)
- Vapor saturation pressure (Ew)

Note: some of the above parameters depend on the value of the barometric pressure. Using the ROTRONIC HW4 software, a fixed barometric pressure value can be specified. For instructions see the following HW4 manual: **E-M-HW4v3-F2-005**

### 3.4 Analog output signals (HF52 and HF53)

#### **HF52 and HF53**

With the ROTRONIC HW4 software any of the two analog output signals can be made to correspond to one of the following:

- Relative humidity
- Temperature
- Calculated parameter

Any output can also be disabled.

The scale of each analog output can be set within the numerical limits of -999.99 and 9999.99. The D/A converters used to generate the analog output signals feature a 16-bit resolution.

#### **HF53**

The type of output signal can be changed by means of jumpers to one of the following: 0...20 mA, 4...20 mA, 0...1V, 0...5V or 0...10V (see 5.2). Both output signals are automatically configured with the same signal type. No adjustment is required after changing the type of output signal.

<b>E-M-HF5-V1_25</b> Document code	Rotronic AG Bassersdorf, Switzerland Unit
<b>HygroFlex HF5 Humidity Temperature Transmitters: User Guide</b> Document title	<b>Instruction Manual</b> Document Type Page 7 of 30

### 3.5 Digital interface (HF53 with digital option and HF55)

#### a) RS-485 serial interface

All HF5 models with a digital interface have a RS-485 serial port. When the number of available network ports is limited, this port can be used to connect together up to 64 devices in a multi-dropped arrangement. In principle, an unlimited number of such networks can be monitored with the HW4 software, but each RS-485 multi-drop network is limited to 64 devices. The HF5 can be used either as a slave or a master, without special configuration. The master is automatically the device that is directly connected to a network (PC or LAN) by means of a USB port or TCP/IP port.

**RS-485 Compatibility:** The communication protocol used by the HF5 and other AirChip 3000 products is not compatible with the protocol used by the previous generation of ROTRONIC instruments. Do not connect legacy products and AirChip 3000 products to the same RS-485 multi-drop network.

#### b) USB or Ethernet interface

The HF5 is also available with the following interface combinations: USB + RS-485 or Ethernet +RS-485. In this case the protection grade of the HF5 enclosure is no longer IP65 / NEMA 4 rated.

### 3.6 Service connector

The service connector is a UART digital interface (Universal Asynchronous Receiver Transmitter) with a mini-USB type connector. This allows connecting the HF5 with a service cable to a PC running the ROTRONIC HW4 software. See "Maintenance" for the location of the service connector and for the type of service cable to be used. The service connector is used to configure the HF5 and to and update its firmware with the HW4 software.

**Note:** the digital interface (USB, Ethernet and RS-485) offers the same functionality as the service connector.

### 3.7 Probe

The HF5 is compatible with all available models of HygroClip 2 probes. For detailed information on the probes see document **E-M-HC2 Probes-V1**.

## 4 User configurable settings and functions

The HF5 ships configured as specified on the customer order. Models with analog outputs can be installed and used just as any conventional humidity and temperature transmitter and most users will never need to use the HF5 configurable settings and functions. Models with a digital interface generally require some configuration by the user.

Making use of the HF5 and probe configurable settings and functions is entirely up to the user and the appropriate settings depend on the user application. We have provided below a short description of the HF5 and probe functions and also indicated the factory default settings.

<b>E-M-HF5-V1_25</b> Document code	Rotronic AG Bassersdorf, Switzerland Unit
<b>HygroFlex HF5 Humidity Temperature Transmitters: User Guide</b> Document title	<b>Instruction Manual</b> Document Type Page 8 of 30

## 4.1 Function overview

<b>MEASUREMENT ACCURACY AND RELIABILITY (PROBE FUNCTIONS)</b>	
<b>AirChip 3000 Functions</b>	<b>Description</b>
▶ Humidity / temperature adjustment	<ul style="list-style-type: none"> <li>○ 1-point or multi-point humidity calibration or adjustment</li> <li>○ 1-point or 2-point temperature calibration or adjustment</li> <li>○ Generate a time stamp for calibrations and adjustments</li> <li>○ Retain and view last adjustment date and adjustment values</li> <li>○ Generate calibration and adjustment protocols</li> </ul>
▶ Automatic humidity sensor test and optional drift compensation	<p>Tests the humidity sensor for drift caused by contaminants and can be used to automatically apply a correction. The test is automatically carried out at regular intervals of time. Can be configured, enabled, or disabled</p> <p>The humidity sensor status can be verified either with the HW4 software or with the instrument display (if available) and is shown as Good, SQ-tuned (corrected for drift) or Bad (defective)</p> <p><b>Not available when the probe is connected to a HF52</b></p>
▶ Data recording	<p>The data recording function differs from a true data logging function in the sense that the AirChip 3000 does not time stamp the data. The data recording function can be use to investigate events such as a sensor malfunction as well as to retrieve data that would otherwise be lost</p> <ul style="list-style-type: none"> <li>○ Start or stop data recording - up to 2000 value pairs (%RH and temperature). Starting a recording session erases all previously recorded data</li> <li>○ The recording mode and log interval can be specified</li> <li>○ When the device is powered off, the recording session is paused but not ended. As long as the recording session has not been ended, the device automatically resumes recording data when powered up again</li> <li>○ The recorded data can be downloaded to a PC with the HW4 software, time stamped and viewed</li> </ul> <p><b>Not available when the probe is connected to a HF52</b></p>

<b>MEASUREMENT LOOP VALIDATION</b>	
<b>Functions</b>	<b>Description</b>
▶ Simulator mode	Used to make the HF5 generate fixed values for the humidity, temperature and calculated parameter. Can be configured, enabled or disabled



<b>E-M-HF5-V1_25</b> Document code	Rotronic AG Bassersdorf, Switzerland Unit
<b>HygroFlex HF5 Humidity Temperature Transmitters: User Guide</b> Document title	<b>Instruction Manual</b> Document Type Page 9 of 30

DEVICE SAFEGUARDS	
Functions	Description
▶ Device write protection	Used to protect the HF5 with a password to prevent unauthorized digital access by a digital user. Can be configured, enabled or disabled
▶ Internal menu access from keypad	Used to prevent accidental changes to the HF5 settings and temperature-humidity adjustment by disabling the MENU key on the optional keypad. Can be enabled or disabled

PROCESS PROTECTION AND PROTECTION OF OTHER DEVICES	
AirChip 3000 Functions	Description
▶ Limit humidity output to 100 %RH	This probe function is used to prevent the humidity signal from exceeding 100 %RH when condensation forms on the sensor. Can be enabled or disabled
▶ Out-of-limit value alarm	Used to specify the normal range for humidity, temperature and the calculated parameter depending on the user application. Can be configured, enabled or disabled  Out-of-limit values trigger a digital alarm which can be also be seen on the optional display
▶ Bad sensor alarm	This is a built-in probe function. Cannot be disabled  A bad humidity or temperature sensor triggers a digital alarm which can be also be seen on the optional HF5 display provided that the HF5 is set to monitor probe alarms
▶ Fail safe mode	Used to specify a "safe" fixed value for humidity and for temperature (HF5 or probe) in the event of: <ul style="list-style-type: none"> <li>○ Loss of communication with the probe (HF5 function)</li> <li>○ Sensor failure (probe function)</li> </ul> Can be configured, enabled or disabled

## 4.2 Interaction between the HF5 and probe functions

It is important to note that when used together, the HF5 transmitter and HC2 probe (HygroClip 2) constitute a 2-component system. Each system component has its own microprocessor, firmware and functions. Some of these functions are unique to each system component. Other functions are found in both components.

**HF52** (2-wire, loop powered transmitter): due to the necessity of limiting the current consumption of the combination of HF52 and HC2 probe to less than 4 mA, several probe functions such as RH sensor test, data recording and probe adjustment are not available with the HF52.

The functions and settings of the HF5 transmitter and HygroClip 2 probe (HC2) operate together as indicated below:

Function / Setting	HF5	HC2	Notes
Device protection	X	X	Individual to the HF5 and HC2 probe
RS-485 address	X	X	Individual to the HF5 and HC2 probe

<b>E-M-HF5-V1_25</b>	Rotronic AG Bassersdorf, Switzerland
Document code	Unit
<b>HygroFlex HF5 Humidity Temperature Transmitters: User Guide</b>	<b>Instruction Manual</b>
Document title	Document Type
	Page <b>10</b> of 30

Function / Setting	HF5	HC2	Notes
Device Name	X	X	User defined description The device name of the HC2 probe is not displayed by HW4 and is replaced with the HF5 Input Name
Calculation	X	X	Psychrometric calculation HF5 setting overrides HC2 probe setting
Data refresh rate	X		This setting has no effect on the HF5 and probe. Depending on the model, the data refresh rate is as follows:  HF52: typically 5 s HF53 and HF55: typically 1 s
Simulator function	X	X	Generates fixed humidity and / or temperature value When enabled, the HF5 settings override the HC2 probe settings
Unit system	X	X	The HF5 setting overrides HC2 probe setting regarding the HF5 signals. The HC2 probe settings still apply when the probe is used alone  <b>Make sure to use the same humidity symbol and the same temperature unit for both the HF5 and probe.</b>
Out-of-limits value alarm	X	X	The HF5 settings are independent from the HC2 probe settings.  The HC2 probe settings have an effect only when the HF5 is enabled to monitor alarms generated by the probe  When out-of-limit values have been defined for the same parameter for both the HF5 and probe, any alarm is triggered based on the narrowest set of limits (assuming that the HF5 has been set to monitor probe alarms).
Analog outputs	X	X	Parameter and scale The HC2 probe settings have no effect on the HF5

<b>E-M-HF5-V1_25</b>	Rotronic AG Bassersdorf, Switzerland
Document code	Unit
<b>HygroFlex HF5 Humidity Temperature Transmitters: User Guide</b>	<b>Instruction Manual</b>
Document title	Document Type
	Page 11 of 30

### 4.3 HF53 output signal type

The type of analog output signals generated by the HF53 can be configured as follows by means of the jumpers located on the upper PCB:

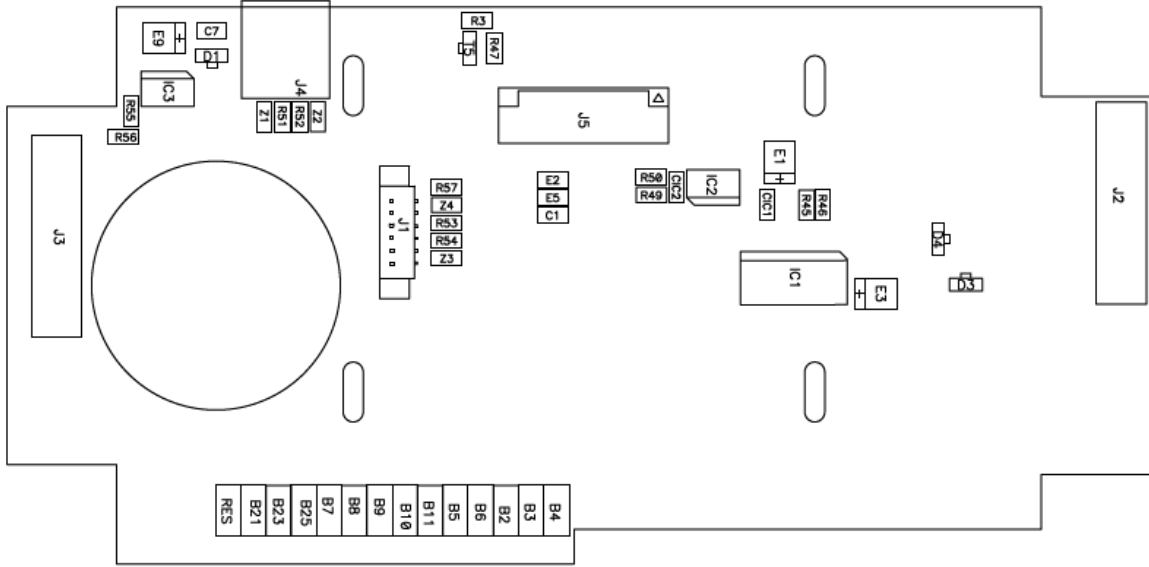

	B2	B3	B4	B5	B6	B7	B8	B9	B10	B11	B21	B23	B25
0...1V	X			X		X			X				X
0...5V		X		X			X		X			X	
0...10V			X	X				X	X			X	X
0...20mA	X				X	X				X	X		
4...20mA	X				X	X				X	X		X

<b>E-M-HF5-V1_25</b> Document code	Rotronic AG Bassersdorf, Switzerland Unit
<b>HygroFlex HF5 Humidity Temperature Transmitters: User Guide</b> Document title	<b>Instruction Manual</b> Document Type Page 12 of 30

## 5 Mechanical installation

### 5.1 General guidelines

Relative humidity is extremely dependent on temperature. Proper measurement of relative humidity requires that the probe and its sensors be at exactly the temperature of the environment to be measured. Because of this, the location where you choose to install the probe can have a significant effect on the performance of the instrument. The following guidelines should guarantee good instrument performance:

- a) **Select a representative location:** install the probe where humidity, temperature and pressure conditions are representative of the environment to be measured.
- b) **Provide good air movement at the probe:** air velocity of at least 200 ft/ minute (1 meter/second) facilitates adaptation of the probe to changing temperature.
- c) **Avoid the following:** (1) Close proximity of the probe to a heating element, a cooling coil, a cold or hot wall, direct exposure to sun rays, etc. (2) Close proximity of the probe to a steam injector, humidifier, direct exposure to precipitation, etc. (3) Unstable pressure conditions resulting from excessive air turbulence.
- d) **Immerse as much of the probe as possible in the environment to be measured.**
- e) **Prevent the accumulation of condensation water at the level of the sensor leads.** Install the probe so that the probe tip is looking downward. If this is not possible, install the probe horizontally.

### 5.2 HF5 enclosure

The HF5 enclosure consists of a base and a cover held together with 4 screws. To open the enclosure, use a metric 2.5 mm hex key. Prior to re-assembling the enclosure, verify that the red seal is sitting properly in its groove on the base.

<b>E-M-HF5-V1_25</b> Document code	Rotronic AG Bassersdorf, Switzerland Unit
<b>HygroFlex HF5 Humidity Temperature Transmitters: User Guide</b> Document title	<b>Instruction Manual</b> Document Type
	Page 13 of 30

### 5.3 Installation of the HF5 type D (through wall mount)

#### *Mounting position of the enclosure*

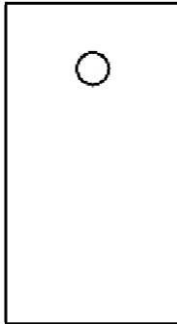

#### **Vertical:**

- HF52 type D without keypad and display
- HF53 type D without keypad and display, and without digital option

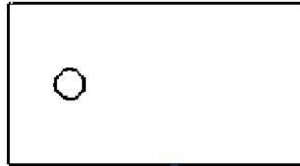

#### **Horizontal:**

- HF52 type D with keypad and display
- HF53 type D with keypad and display or with digital option
- HF55 type D

#### *Mounting hardware*



The **QMA-15** consists of a flange and compression fitting and is designed to hold the probe of the HF5 type D when mounted through a wall (see Accessories). The HF5 does not require any additional support.

### 5.4 Installation of the HF5 type W (surface mount)

#### *Mounting position of the enclosure*

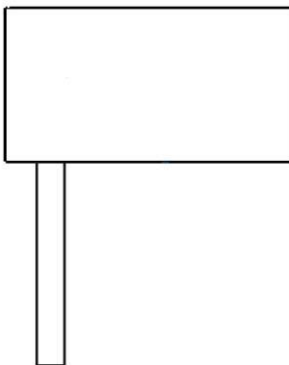

#### **Horizontal:**

HF52, HF53 and HF55 type W

<b>E-M-HF5-V1_25</b> Document code	Rotronic AG Bassersdorf, Switzerland Unit
<b>HygroFlex HF5 Humidity Temperature Transmitters: User Guide</b> Document title	<b>Instruction Manual</b> Document Type
	Page <b>14</b> of 30

### **Mounting hardware**

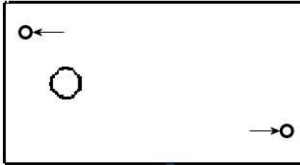

**Method 1:** The HF5 is supplied with 2 screws, 2 drywall anchors and two rubber washers. The base of the enclosure has 2 screw-wells (see drawing) that are normally closed at the bottom. Use the template provided with the HF5 to drill mounting holes in the wall and insert the drywall anchors. Place a rubber washer on each screw. Insert a screw in each well and push to open the bottom of the well.



**Method 2:** When a DIN-rail (35 mm / 1 3/8 ") is available use part **AC5002** (not included). This is a DIN-rail mounting kit consisting of 2 clamps that attach to the back of the enclosure with the screws provided.

## **6 Electrical installation**

### **6.1 General wiring guidelines**

#### **Power supply wiring**

Heavy machinery and instrumentation should not share the same power supply wiring. If this cannot be avoided, noise filters and surge protectors should be used. Most UPS devices have those features already integrated.

#### **General guidelines for signal cables**

The following guidelines are derived from European Standard EN 50170 for the transmission of signals by copper wires. When planning an installation, the rules provided by EN 50170 should be followed under consideration of local circumstances to determine the position of machines and equipment.

All ROTRONIC products are tested for Electromagnetic Compatibility according to EMC Directive 2004/106/EG and following European standards:

- EN 61000-6-1: 2001, EN 61000-6-2: 2005
- EN 61000-6-3: 2005, EN 61000-6-4: 2001 + A11

Whenever the level of electromagnetic interference is expected to be high, both the instruments and signal cables should be placed as far away as possible from the source of interference.

In general, signal cables should be installed in bundles or channels / conduits, separate from other cables as indicated in the table below:

<b>E-M-HF5-V1_25</b> Document code	Rotronic AG Bassersdorf, Switzerland Unit
<b>HygroFlex HF5 Humidity Temperature Transmitters: User Guide</b> Document title	<b>Instruction Manual</b> Document Type Page 15 of 30

<ul style="list-style-type: none"> <li>• Bus signals such as RS485</li> <li>• Data signals for PCs, printers etc.</li> <li>• shielded analog inputs</li> <li>• unshielded direct current (&lt;= 60V)</li> <li>• shielded process signals (&lt;= 25 V)</li> <li>• unshielded alternate current (&lt;= 25V)</li> <li>• coaxial cables for CRT monitors</li> </ul>	<b>in common bundles or channels / conduits</b>
<ul style="list-style-type: none"> <li>• direct current from 60 V to 400 V (unshielded)</li> <li>• alternate current from 25V to 400 V (unshielded)</li> </ul>	<b>in separated bundles or channels / conduits, without minimum distance</b>
<ul style="list-style-type: none"> <li>• direct and alternate current &gt; 400 V (unshielded)</li> <li>• Telephone lines</li> <li>• lines leading into EX-rated areas</li> </ul>	<b>in separated bundles or channels / conduits, without minimum distance</b>

### ***Lightning protection***

Cabling in areas with a risk of lightning requires a lightning protection. For cabling underground in between buildings, we recommend the use of special fiber optic cables. If this is not possible, use copper cables that are suitable for underground installation.

## **6.2 Guidelines for RS-485 wiring (HF53 with digital option and HF55)**

See document **E-DV04-RS485.01**: RS485 Network Installation and Start-up Guidelines

## **6.3 Cable grip and cable specifications**

The HF5 is supplied either with one M16 sealing cable grip or with a ½" conduit adapter. The M16 cable grip provides effective sealing only with cables having the proper outside diameter. Preferably, use a cable with an outside diameter of 6 to 7 mm (0.236 to 0.275 inch) with 18 AWG wires.

<b>E-M-HF5-V1_25</b>	Rotronic AG Bassersdorf, Switzerland
Document code	Unit
<b>HygroFlex HF5 Humidity Temperature Transmitters: User Guide</b>	<b>Instruction Manual</b>
	Document Type
Document title	Page 16 of 30

## 6.4 Wiring

### 6.4.1 HF52: 2-wire, loop powered transmitter

#### Electrical diagram

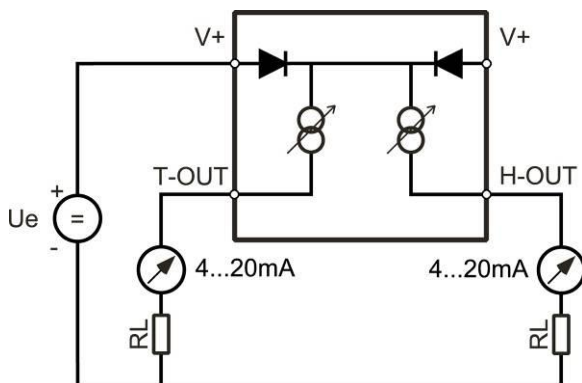

The maximum permissible cable length connecting the HF52 to other devices is determined by the total resistance resulting from the addition of the cable resistance and that of the devices connected in series with the unit. This resistance should not exceed 500 ohms.

#### Terminal block diagram

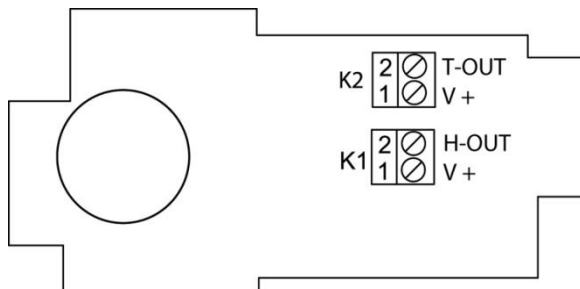

Terminals	Description
K2-2: T-OUT	Temperature output (+) OUT-2
K2-1: V+	Power supply: 10...28 VDC (+)

Terminals	Description
K1-2: H-OUT	Relative humidity or dew point (+) OUT-1
K1-1: V+	Power supply: 10...28 VDC (+)

**Note:** connect the + of the power supply to only one of the V+ terminals. The two terminals marked V+ are internally connected.

#### Measuring humidity or temperature only

Unless configured to measure either humidity only or temperature only, proper operation of the HF52 requires both current loops to be closed. The HF52 can be directly ordered from the factory to measure either humidity or temperature only. When necessary, any unused output of the HF52 can be disabled with the ROTRONIC HW4 software. When the HF52 is configured with one of the two outputs disabled, close only the loop that is being used.



<b>E-M-HF5-V1_25</b>	Rotronic AG Bassersdorf, Switzerland
Document code	Unit
<b>HygroFlex HF5 Humidity Temperature Transmitters: User Guide</b>	<b>Instruction Manual</b>
Document title	Document Type
	Page 17 of 30

### 6.4.2 HF53: 3-wire transmitter

#### Electrical diagram for voltage outputs

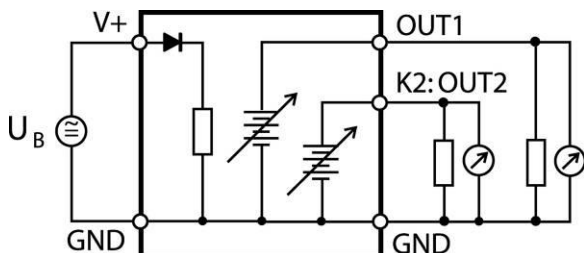

The maximum permissible cable length can be determined under consideration of the voltage drop caused by the current flowing to the devices connected to the unit. The voltage drop in the cable depends both on cable resistance and on the equivalent resistance of the devices connected in parallel to the unit. The total resistance connected to each unit output should be at least 1000 ohms. Cable resistance should not be more than 1/1000 of the load resistance.

#### Electrical diagram for current outputs

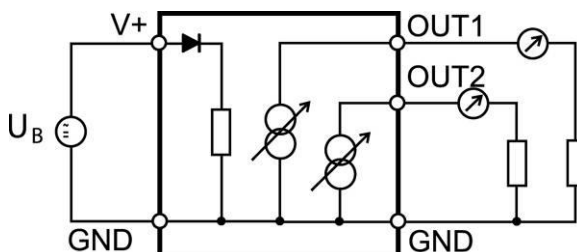

The maximum permissible cable length, connecting the unit to other devices, is determined by the total resistance resulting from the addition of the cable resistance and that of the devices connected in series with the unit. This resistance should not exceed 500 ohms.

#### Terminal block diagram (analog outputs only)

Type D and W (horizontal mount)

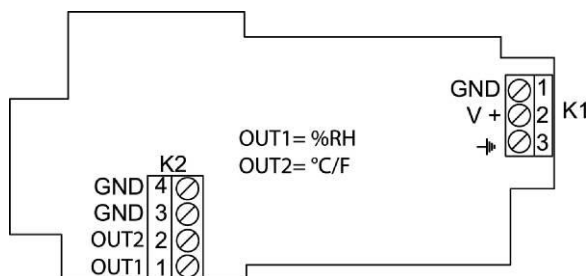

Terminals	Description
K1-1: GND	Power supply (-) or neutral (tied with other GND)
K1-2: V+	Power supply: 15...40 VDC (+) or 12...28 VAC (Phase)
K1-3: -▶	Protective ground (see note below)

Terminals	Description
K2-4: GND	Ground (tied with other GND)
K2-3: GND	Ground (tied with other GND)
K2-2: OUT2	Temperature output (+)
K2-1: OUT1	Relative humidity or dew point (+)

<b>E-M-HF5-V1_25</b>	Rotronic AG Bassersdorf, Switzerland
Document code	Unit
<b>HygroFlex HF5 Humidity Temperature Transmitters: User Guide</b>	<b>Instruction Manual</b>
	Document Type
Document title	Page 18 of 30

Type D (vertical mount)

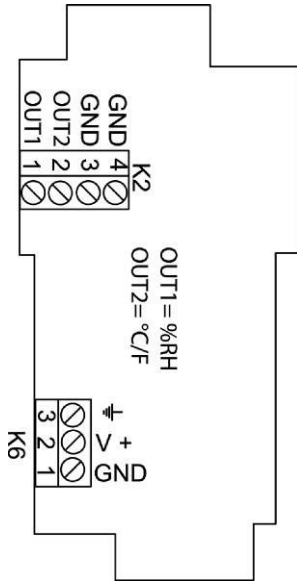

Terminals	Description
K2-4: GND	Ground (tied with other GND)
K2-3: GND	Ground (tied with other GND)
K2-2: OUT2	Temperature output (+)
K2-1: OUT1	Relative humidity or dew point (+)

Terminals	Description
K6-1: GND	Power supply (-) or neutral (tied with other GND)
K6-1: V+	Power supply: 15...40 VDC (+) or 12...28 VAC (Phase)
K6-3: -▶	Protective ground (see note below)

**Note:** Terminals K1-3 or K6-3 (protective or earth ground) are not tied with GND. If so desired, K1-3 or K6-3 can be tied with GND by closing a solder pad on the PCB

<b>E-M-HF5-V1_25</b>	Rotronic AG Bassersdorf, Switzerland
Document code	Unit
<b>HygroFlex HF5 Humidity Temperature Transmitters: User Guide</b>	<b>Instruction Manual</b>
Document title	Document Type
	Page 19 of 30

**Terminal block diagram (analog outputs and digital option)**

Type D and W (horizontal mount)

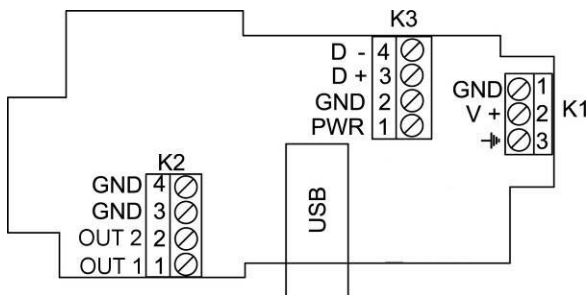

Terminals	Description
K1-1: GND	Power supply (-) or neutral (tied with other GND)
K1-2: V+	Power supply: 15...40 VDC (+) or 12...28 VAC (Phase)
K1-3: -▶	Protective ground (see note below)

Terminals	Description
K2-4: GND	Ground (tied with other GND)
K2-3: GND	Ground (tied with other GND)
K2-2: OUT2	Temperature output (+)
K2-1: OUT1	Relative humidity or dew point (+)

Terminals	Description
K3-4: D-	RS-485 Bi-directional TX- / RX -
K3-3: D+	RS-485 Bi-directional TX+ / RX +
K3-2: GND	Ground / Power supply (-)
K3-1: PWR	DC (+) 15...24 VDC (+) (optional, see note below)

**Notes:**

**Terminal K1-3:** this terminal (protective or earth ground) is not tied with GND. If so desired, K1-3 can be tied with GND by closing a solder pad on the PCB

**Terminal block K3 (RS-485):** with the exception of models with the galvanically isolated power supply option, terminals K3-1 and K3-2 can be used to power the HF53 from a 15 to 24 VDC power supply connected to the RS-485 main data line. In this case, do not use terminals K1-1 and pin K1-2 (normally used to power the HF53).

**USB port:** depending on the ordering code the HF53 may or may not be equipped with this port

**Measuring humidity or temperature only**

Operation of the HF53 does not require both current loops to be closed. When using the HF53 to measure either humidity only or temperature only, close only the loop that is being used.

Using the ROTRONIC HW4 software, any unused output of the HF53 can be disabled.

<b>E-M-HF5-V1_25</b>	Rotronic AG Bassersdorf, Switzerland
Document code	Unit
<b>HygroFlex HF5 Humidity Temperature Transmitters: User Guide</b>	<b>Instruction Manual</b>
Document title	Document Type
	Page <b>20</b> of 30

### 6.4.3 HF55: digital output

#### Connectors and terminal block diagram

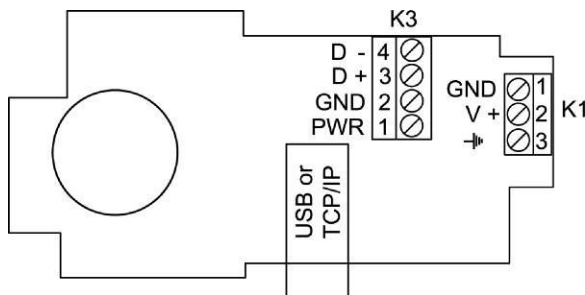

Terminals	Description
K1-1: GND	Power supply (-) or neutral (tied with other GND)
K1-2: V+	Power supply: 5...40 VDC (+) or 12...28 VAC (Phase)
K1-3: -▶	Protective ground (see note below)

Terminals	Description
K3-4: D-	RS-485 Bi-directional TX- / RX -
K3-3: D+	RS-485 Bi-directional TX+ / RX +
K3-2: GND	Ground / Power supply (-)
K3-1: PWR	DC (+) 15...24 VDC (+) (optional, see note below)

#### Notes:

**Terminal K1-3:** this terminal (protective or earth ground) is not tied with GND. If so desired, K1-3 can be tied with GND by closing a solder pad on the PCB

**Terminal block K3 (RS-485):** with the exception of models with the galvanically isolated power supply option, terminals K3-1 and K3-2 can be used to power the HF55 from a 15 to 24 VDC power supply connected to the RS-485 main data line. In this case, do not use terminals K1-1 and pin K1-2 (normally used to power the HF55).

**WARNING:** Connecting a device to an active Ethernet network can disrupt communications on the network. Before connecting the HF5, make sure that it is properly configured for your network.

### 6.4.4 Grounding (all models)

We generally recommend grounding the (-) side of the power supply, especially if the electronics will be subjected to a low humidity environment (35 %RH or less).

<b>E-M-HF5-V1_25</b> Document code	Rotronic AG Bassersdorf, Switzerland Unit
<b>HygroFlex HF5 Humidity Temperature Transmitters: User Guide</b> Document title	<b>Instruction Manual</b> Document Type Page 21 of 30

## 7 Operation

### 7.1 HF52 and HF53 transmitters (analog outputs)

Use the HW4 software to configure the HF5 as desired, complete the mechanical and electrical installation, connect the probe and simply power up the HF5.

### 7.2 HF53 with digital option and HF55

Both the HF53 with digital option and the HF55 use the standard RO-ASCII protocol and do not offer any other option. Users who wish to read the measurement data without the HW4 software should consult ROTRONIC.

The different types of digital interface available with the HF5 are best used with a PC with the HW4 software installed (version 2.1.0 or higher). In principle, users should be able to use communication software other than HW4 to read measurement data from the HF5. In this case, communication is limited to the **RDD** (data request) and **REN** (RS-485 address change) commands described separately in document E-M-AC3000-CP.

**IMPORTANT: Depending on the type of digital interface, either the PC or the HF5 must be configured by the user as indicated below.**

#### a) USB connection

Prior to connecting the HF5 to a USB port you must install the **ROTRONIC USB driver** on the PC (available from the HW4 CD or from [www.rotronic-humidity.com](http://www.rotronic-humidity.com)). For instructions see the HW4 manual **E-M-HW4v3-Main** (§ 7.3)

#### b) Ethernet (TCP/IP) connection (wired or wireless)

Prior to connecting the HF55 to an active Ethernet network you must configure the TCP/IP settings of the HF55 using either the HW4 software (version 2.1.0 or higher) or the TCP/IP configuration tool available from [www.rotronic-humidity.com](http://www.rotronic-humidity.com). For instructions see the HW4 manual **E-M-HW4v3-Main** (§ 7.4) and technical note **IN-E-TCPIP-Conf**

**WARNING:** Connecting a device to an active Ethernet network can disrupt communications on the network. Before connecting the HF5, make sure that it is properly configured for your network

#### c) RS-485 serial interface (multi-drop)

Instructions for using the HF5 with a RS-485 network are provided in the following manuals: **E-M-HW4v3-Main** (§ 7.5), **E-M-HW4v3-F2-005** and **E-DV04-RS485.01**.

#### Notes:

- Instruments connected to the same RS-485 network must use the same baud rate and each instrument must be given a unique RS-485 address (the address requirement applies to the HF5 but not to its probe)
- **RS-485 Compatibility:** The communications protocol used by the HF5 is the RO-ASCII protocol. This protocol is not compatible with the protocol used by the previous generation of ROTRONIC products. Do not connect legacy products and the HF5 to the same RS-485 multi-drop network.

<b>E-M-HF5-V1_25</b> Document code	Rotronic AG Bassersdorf, Switzerland Unit
<b>HygroFlex HF5 Humidity Temperature Transmitters: User Guide</b> Document title	<b>Instruction Manual</b> Document Type Page 22 of 30

The specifications of the RS-485 interface are as follows:

Baud rate : 19200  
Parity : none  
Data bits : 8  
Stop bits : 1

### 7.3 Internal menu (optional keypad and display)

Note: Unauthorized access to the menu can be prevented by disabling the “display menu” setting (use the HW4 software > Device Manager > Display)

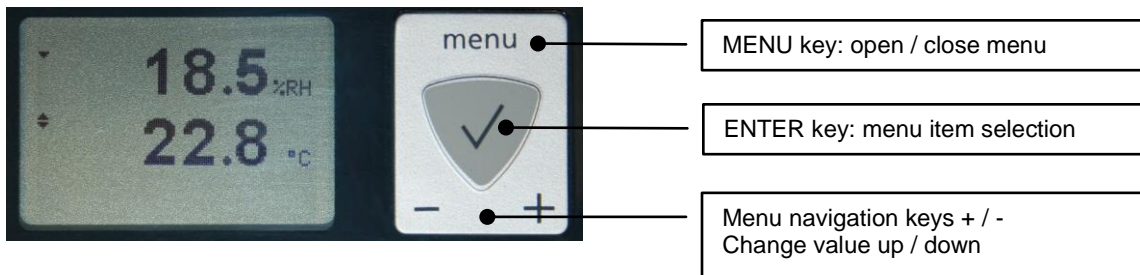

HF52 transmitter:

Main Menu	Menu Items	Selections / Information	Notes
<b>Device Settings</b>			
	<b>Units</b>	Metric / English	
	<b>Contrast</b>		LC display contrast adjustment
	<b>Trend</b>	On / Off	Trend indication on the display
<b>Device Information</b>			
	<b>Version</b>	Firmware version	
	<b>Serial Nbr</b>	Serial number	
	<b>Address</b>	RS-485 address	
	<b>Type</b>	Device type	
	<b>Name</b>	Device name	User defined
<b>Probe Information</b>			
	<b>Version</b>	Firmware version	
	<b>Serial Nbr</b>	Serial number	
	<b>Address</b>	RS-485 address	
	<b>Name</b>	Device name	User defined

<b>E-M-HF5-V1_25</b> Document code	Rotronic AG Bassersdorf, Switzerland Unit
<b>HygroFlex HF5 Humidity Temperature Transmitters: User Guide</b> Document title	<b>Instruction Manual</b> Document Type Page 23 of 30

**HF53 and HF55 transmitters:**

Main Menu	Menu Items	Selections / Information	Notes
<b>Device Settings</b>			
	<b>Units</b>	Metric / English	
	<b>Back Light</b>	Key Press / On / Off	Display backlight mode
	<b>Contrast</b>		LC display contrast adjustment
	<b>Trend</b>	On / Off	Trend indication on the display
<b>Device Information</b>			
	<b>Version</b>	Firmware version	
	<b>Serial Nbr</b>	Serial number	
	<b>Address</b>	RS-485 address	
	<b>Type</b>	Device type	
	<b>Name</b>	Device name	User defined
<b>Probe Information</b>			
	<b>Version</b>	Firmware version	
	<b>Serial Nbr</b>	Serial number	
	<b>Address</b>	RS-485 address	
	<b>Name</b>	Device name	User defined
	<b>SensorTest</b>	Humidity sensor status	Off / Good / SQ-Tuned / Bad
	<b>Record</b>	On / Off	Data recording by the probe (max. 2000 values)
<b>Humidity Adjust</b>			
	<b>RefValue</b>	Humidity reference value	± 0.1 %RH steps
	<b>Acquired</b>		Number of cal. points in probe memory
	<b>&lt;Acquire&gt;</b>		Save cal. point to probe memory
	<b>&lt;Delete&gt;</b>		Erases all calibration points
	<b>&lt;Adjust&gt;</b>		Effect depends on number of calibration points
<b>Temperature Adjust</b>			
	<b>RefValue</b>	Temperature reference value	± 0.1 °C steps
	<b>&lt;Adjust&gt;</b>		1-point adjustment only (offset)

- **Record:** both the recording mode (start / stop and the log interval cannot be changed from the menu and are as configured with the ROTRONIC HW4 software
- **SensorTest:** Off means that the humidity sensor has not been tested due to the configuration settings of the test. For a description of the automatic humidity sensor test and drift compensation (SQ-tuning) see documents **E-T-AC3000-DF-V1** and **E-M-HW4v3-F2-005**

<b>E-M-HF5-V1_25</b> Document code	Rotronic AG Bassersdorf, Switzerland Unit
<b>HygroFlex HF5 Humidity Temperature Transmitters: User Guide</b> Document title	<b>Instruction Manual</b> Document Type
	Page 24 of 30

## 7.4 Displayed parameters (optional keypad and display)

When the menu is not active, press the ENTER key to change which parameters are shown on the display:

- Relative humidity and temperature
- Relative humidity , temperature and calculated parameter (when the calculated parameter is enabled)

## 8 Maintenance

### 8.1 Service cable

Cable AC3006 is used to connect the HF5 to a USB port of a PC running the ROTRONIC HW4 software. Prior to connecting the HF5 to a USB port you must install the ROTRONIC USB driver on the PC (available from the HW4 CD or from [www.rotronic-humidity.com](http://www.rotronic-humidity.com)). For instructions see the HW4 manual **E-M-HW4v3-Main**.

### 8.2 Location of the service connector (mini USB type)

**WARNING:** the service connector is a UART interface with a mini-USB connector type. Do not connect the service connector directly to the USB port of a PC or hub.

The service connector can be accessed without opening the enclosure after removing the small red sealing cover.

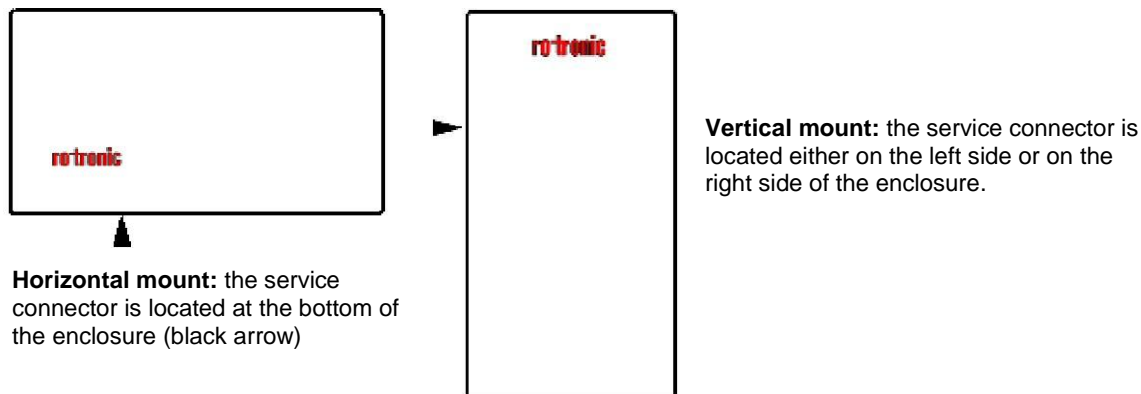

### 8.3 Periodic calibration check of the probe

Both the Pt 100 RTD temperature sensor used in the probe and associated electronics are very stable and should not require any calibration after the initial factory adjustment.

Long term stability of the ROTRONIC Hygromer humidity sensor is typically better than 1 %RH per year. For maximum accuracy, calibration of the probe should be verified every 6 to 12 months. Applications where the probe is exposed to significant pollution may require more frequent verifications.

**Note:** the HygroClip 2 probe cannot be adjusted when connected to the HF52 transmitter



<b>E-M-HF5-V1_25</b> Document code	Rotronic AG Bassersdorf, Switzerland Unit
<b>HygroFlex HF5 Humidity Temperature Transmitters: User Guide</b> Document title	<p style="text-align: right;"><b>Instruction Manual</b></p> Document Type Page 25 of 30

## a) Procedure for adjusting the probe using the optional keypad (HF53 / HF55)

### *Temperature adjustment*

The keypad of the HF53 or HF55 allows only a 1-point adjustment of temperature. The effect of a 1-point temperature adjustment is to add the same offset to all measured values.

- When temperature is stable, press the MENU key to show the internal menu on the display
- Use the (-) key to select Temperature Adjust and press the ENTER key
- Make sure that the text line beginning with RefValue is highlighted and press the ENTER key
- Use the (+) or (-) key to change the reference value to match the temperature reference
- Use the (-) key to highlight the Adjust text line and press the ENTER key
- The HF5 confirms the adjustment with the message "Adjust OK"
- Press the MENU key twice to exit the menu and return the HF5 to normal operation

#### **Notes:**

- Any temperature adjustment should be done prior to adjusting humidity.
- The calibration point is automatically deleted from the probe memory after an adjustment
- Because the HF5 has no real time clock, the date of the adjustment is not written to the probe. If retaining the adjustment date is important, use the HW4 software to adjust the probe.

### *Humidity adjustment*

The keypad of the HF53 or HF55 allows a multi-point adjustment of humidity. The effect of a humidity adjustment depends on the number of calibration points present in the probe memory prior to the adjustment:

- one calibration point: offset added to all measured values
- two calibration points: offset and slope
- three or more calibration points: offset, slope, linearity

For maximum accuracy use at least 3 to 4 calibration points distributed equally across the measurement range of interest. The calibration points (maximum 100) can be acquired in any order but we recommend going from low humidity values to high humidity values.

- When humidity is stable, press the MENU key to show the internal menu on the display
- Use the (-) key to select Humidity Adjust and press the ENTER key
- Make sure that the text line beginning with RefValue is highlighted and press the ENTER key
- Use the (+) or (-) key to change the reference value to match the reference humidity
- Use the (-) key to highlight the Acquire text line and press the ENTER key
- Note that the "Acquired" counter is incremented by 1 (number of calibration points in the probe memory)
- When all calibration points have been acquired, use the (-) key to highlight the Adjust text line and press the ENTER key. **Do not adjust the probe before having acquired all calibration points.**
- The HF5 confirms the adjustment with the message "Adjust OK"
- Press the MENU key twice to exit the menu and return the HF5 to normal operation

#### **Notes:**

- All calibration points are automatically deleted from the probe memory after an adjustment
- Instructions for using the ROTRONIC calibration devices and humidity standards are provided in document **E-M-CalBasics**
- Because the HF5 has no real time clock, the date of the adjustment is not written to the probe. If retaining the adjustment date is important, use the HW4 software to adjust the probe.

<b>E-M-HF5-V1_25</b> Document code	Rotronic AG Bassersdorf, Switzerland Unit
<b>HygroFlex HF5 Humidity Temperature Transmitters: User Guide</b> Document title	<b>Instruction Manual</b> Document Type Page 26 of 30

#### b) Using the HW4 software to adjust the probe connected to a HF53 or HF55:

- Use cable AC3006 to connect the service connector of the HF5 to a USB port of a PC with the HW4 software installed. Note that the ROTRONIC USB driver must be installed on the PC as explained in the HW4 manual **E-M-HW4v3-Main**. In the case of the HF55, a connection with the PC can be established via the USB (ROTRONIC USB driver) or Ethernet interface.
- Start HW4 on the PC and search for the HF5 (HW4 Main Menu Bar > Devices and Groups > Search for USB Masters).
- After finding the HF5 with HW4, expand the device tree to see the HF5 functions. Select Probe and Probe Adjustment.
- For further instructions see HW4 manual **E-M-HW4v3-A2-001**

## 8.4 Cleaning or replacing the probe dust filter

See document **E-M-HC2 Probes-V1**

## 8.5 Validation of the output signals transmission

If so desired, transmission of the HF5 output signals can be validated by using the simulator function. The HW4 software is required to enable and configure this function. When this function is enabled the HF5 generates fixed digital and analog signals as specified by the user. For instructions see document **E-M-HW4v3-F2-005**

## 9 Firmware updates

Firmware updates will be available on the ROTRONIC website for downloading. Firmware files are given a name that shows both to which device the file applies and the version number of the firmware. All firmware files have the extension HEX. Procedure for updating the firmware:

- Use cable AC3006 to connect the service connector of the HF5 to a USB port of a PC with the ROTRONIC HW4 software installed. Note that the ROTRONIC USB driver must be installed on the PC as explained in the HW4 manual **E-M-HW4v3-Main**. In the case of the HF55, a connection with the PC can be established via the USB (ROTRONIC USB driver) or Ethernet interface.
- Copy the firmware update file from the ROTRONIC website to the PC.
- Start HW4 software on the PC and search for the HF5 (HW4 Main Menu Bar > Devices and Groups > Search for USB Masters).
- After finding the HF5, expand the device tree to see the HF5 functions. Select Device Manager. In the Device Manager menu bar select Tools > Firmware Update. For instructions see document **E-M-HW4v3-F2-005**

<b>E-M-HF5-V1_25</b> Document code	Rotronic AG Bassersdorf, Switzerland Unit
<b>HygroFlex HF5 Humidity Temperature Transmitters: User Guide</b> Document title	<b>Instruction Manual</b> Document Type Page 27 of 30

## 10 Technical data

### 10.1 Specifications

General	HF52	HF53	HF55
Device type	Humidity temperature transmitter with analog output signals		Humidity temperature transmitter with digital output
Circuit type	2-wire, loop powered	3-wire	
Mechanical configuration types	D and W		

Power supply and connections	HF52	HF53	HF55
Supply voltage (VDD)	10...28VDC V min = 10 V + (0.02 x Load*) *Load resistance in ohms.	Option 1 (standard): 15...40 VDC or 12...28 VAC  Option 2: (galvanically isolated): 9 to 36 VDC or 7 to 24 VAC	Option 1 (standard): 5...40 VDC or 12...28 VAC  Option 2: (galvanically isolated): 9 to 36 VDC or 7 to 24 VAC  Option 3: PoE (not available on models with RS-485 interface)
Typical current consumption	2 x 20 mA	100 mA	Model with USB interface: 100 mA  Model with Ethernet interface: 300 mA
Electrical connections	Terminal block and M16 cable grip or ½" conduit adapter		Connector (USB or Ethernet), terminal block (power supply and RS-485) and M16 cable grip or ½" conduit adapter
Polarity protection	Protective diode on V+		

Humidity and temperature measurement
See document <b>E-M-HC2 Probes</b> > Specifications

Calculated parameters	HF52	HF53	HF55
Psychrometric calculations	Dew point (Dp) above and below freezing Frost point (Fp) below freezing and dew point above freezing Wet bulb temperature (Tw) Enthalpy (H) Vapor concentration (Dv) Specific humidity (Q) Mixing ratio by weight (R) Vapor concentration at saturation (Dvs) Vapor partial pressure (E) Vapor saturation pressure (Ew)		

<b>E-M-HF5-V1_25</b>	Rotronic AG Bassersdorf, Switzerland
Document code	Unit
<b>HygroFlex HF5 Humidity Temperature Transmitters: User Guide</b>	<b>Instruction Manual</b>
Document title	Document Type
	Page 28 of 30

Start-up time and data refresh rate	HF52	HF53	HF55
Start-up time	14 s (typical)	3.s (typical)	3 s (typical)
Data refresh rate	5 s (typical)	1 s (typical)	1 s (typical)

Configurable analog outputs	HF52	HF53
Output 1	Can be made to correspond to any parameter	
Parameter	User configurable with the ROTRONIC HW4 software	
Scale	User configurable with the ROTRONIC HW4 software	
Output 2	Can be made to correspond to any parameter	
Parameter	User configurable with the ROTRONIC HW4 software	
Scale	User configurable with the ROTRONIC HW4 software	
Output 1 and Output 2		
Signal type	4...20 mA	0...20 mA 4... 20 mA 0... 1 V 0... 5 V 0... 10 V (user configurable)
User configurable scaling limits	-999.99 ... +9999.99 engineering units	
Short circuit tolerant	Yes	
Maximum external load	500 Ω	500 Ω (current output)
Minimum external load	0 Ω	1000 Ω (voltage output) 0 Ω (current output)

Digital interface	HF52	HF53 (optional)	HF55
Interface type	N/A	RS-485 or USB and RS-485	RS-485 USB and RS-485 or Ethernet (TCP/IP) wired or wireless and RS-485

Service connector	HF52	HF53	HF55
Interface type	UART (Universal Asynchronous Receiver Transmitter)		
Maximum service cable length	5 m (16.4 ft)		

General specifications	HF52	HF53	HF55
Optional display	LC, 1 or 2 decimals resolution, no backlight, trend and alarm indication	LC, 1 or 2 decimals resolution, backlight, trend and alarm indication	
Probe material	Polycarbonate		
Probe dust filter material	Polyethylene		
Housing material	ABS		
Housing protection grade	IP 65 (except HF53 or HF55 with USB or Ethernet)		
Physical dimensions	See Models		
Weight	250 g (8.8 oz)		250 g (8.8 oz)

<b>E-M-HF5-V1_25</b> Document code	Rotronic AG Bassersdorf, Switzerland Unit
<b>HygroFlex HF5 Humidity Temperature Transmitters: User Guide</b> Document title	<b>Instruction Manual</b> Document Type Page 29 of 30

Conformity with standards	HF52	HF53	HF55
CE / EMC immunity	EMC Directive 2004/108/EG: EN 61000-6-1: 2001, EN 61000-6-2: 2005 EN 61000-6-3: 2005, EN 61000-6-4: 2001 + A11		
Solder type	Lead free (RoHS directive)		
Fire protection class	Corresponds to UL94-HB		
FDA / GAMP directives	compatible		

Environmental limits	HF52	HF53	HF55
Storage and transit	-50...+70 °C / -20...+70 °C (models with display), 0...100 %RH, non condensing		
Operating limits at electronics	-25 ... +60 °C -10...60 °C (models with display) 0...100 %RH non condensing	-40 ... +60 °C -10...60 °C (models with display) 0...100 %RH non condensing	
Temperature limits at probe	Depends on probe model		
Maximum humidity at sensor	100 %RH up to 80 °C (176 °F) 75 %RH at 100 °C (212 °F) 45 %RH at 125 °C (260 °F) 15 %RH at 150 °C (302 °F)		
Maximum air velocity at probe	20 m/s (3,935 ft /min)		
Critical environments	Humidity sensor: as per DV04-14.0803.02 - Critical chemicals		

## 10.2 Dew point accuracy

See document **E-M-HC2 Probes > Dew point accuracy**

## 11 Accessories

For accessories and parts such as the HW4 configuration software, service cables, calibration accessories and spare dust filters, please see document **E-M-HC2-accessories**

## 12 Supporting documents

Document File Name	Contents
<b>E-M-HC2 Probes-V1</b>	HygroClip 2 (HC2) Humidity Temperature Probes, User Guide
<b>E-M-HC2-accessories</b>	Accessories and parts for probes, indicators and transmitters
<b>E-T-AC3000-DF-V1</b>	AirChip 3000 Description and Main Functions
<b>E-M-HW4v3-DIR</b>	List of the HW4 manuals
<b>E-M-HW4v3-Main</b>	HW4 software version 3: General instructions and functions common to all devices
<b>E-M-HW4v3-F2-005</b>	HW4 software version 3: Device Manager - HF5 transmitter

<b>E-M-HF5-V1_25</b> Document code	Rotronic AG Bassersdorf, Switzerland Unit
<b>HygroFlex HF5 Humidity Temperature Transmitters: User Guide</b> Document title	<b>Instruction Manual</b> Document Type Page <b>30</b> of 30

Document File Name	Contents
<b>E-M-HW4v3-F2-001</b>	HW4 software version 3: Device Manager – HC2 probe series
<b>E-M-HW4v3-A2-001</b>	HW4 software version 3: Probe Adjustment function AirChip 3000 devices
<b>E-M-HW4v3-DR-001</b>	HW4 software version 3: Data Recording Function AirChip 3000 Devices
<b>E-M-AC3000-CP</b>	AirChip 3000 Communication Protocol Options
<b>E-DV04-RS485.01</b>	RS485 Network Installation and Start-up Guidelines
<b>E-M-TCPIP-Conf</b>	Configuration procedures for ROTRONIC devices with Ethernet (TCP/IP) interface
<b>E-M-CalBasics</b>	Temperature and humidity calibration basics Instructions for using the ROTRONIC humidity standards
<b>E-T-HumiDefs</b>	Humidity Definitions

**Note:** All document file names have an extension corresponding to the document release number. This extension is not shown in the above table.

## 13 Document releases

Doc. Release	Date	Notes
_20	Jun.16, 2009	Original release
_21	Nov. 9, 2009	Expanded the range of power supply options for the HF53 and HF55 Removed factory defaults specification
_22	Jan. 29, 2010	Changed the typical current consumption data
_23	Feb. 23, 2010	HF53 and HF55 with RS-485 interface: models with the galvanically isolated power supply option cannot be powered from the RS-485 main data line
_24	Jun. 18, 2010	Updated document for HW4 software v.3
_25	Mar. 27, 2013	Changed the HF52 operating limits at electronics